



# Building Materials

## Lecture 3





# Specific surface



- describes fineness
- total surface area per unit of mass
- units:  $\text{m}^2/\text{kg}$  ( $\text{cm}^2/\text{g}$ )
- the higher the specific surface is, the finer material will be



# Specific surface

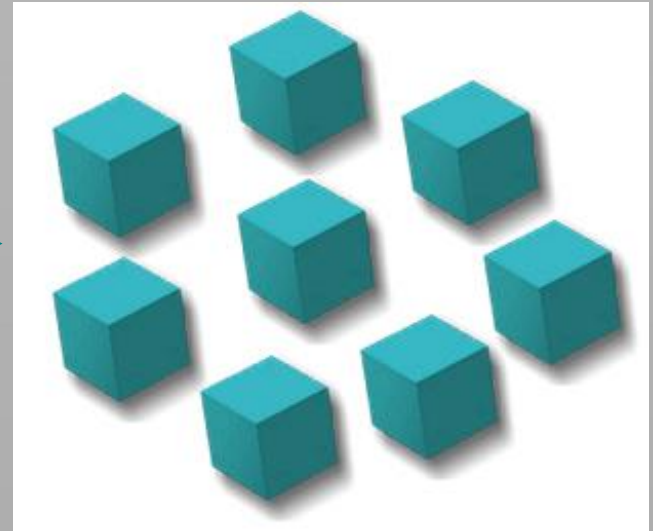
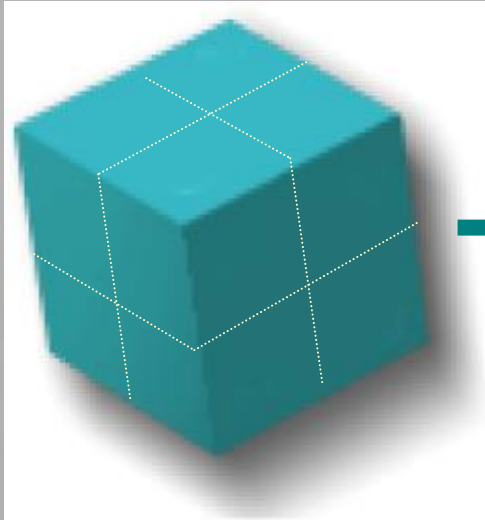

cube 2 x 2 x 2 cm  
each face is 4 cm<sup>2</sup>

$$6 \text{ faces} \times 4 \text{ m}^2 = 24 \text{ cm}^2$$

8 cubes 1 x 1 x 1 cm  
each face is 1 cm<sup>2</sup>

$$6 \text{ faces} \times 1 \text{ m}^2 \times 8 \text{ cubes} = 48 \text{ cm}^2$$

- if each of the resulting cubes was divided similarly, the surface area would increase 16 times more



# Specific surface of some materials

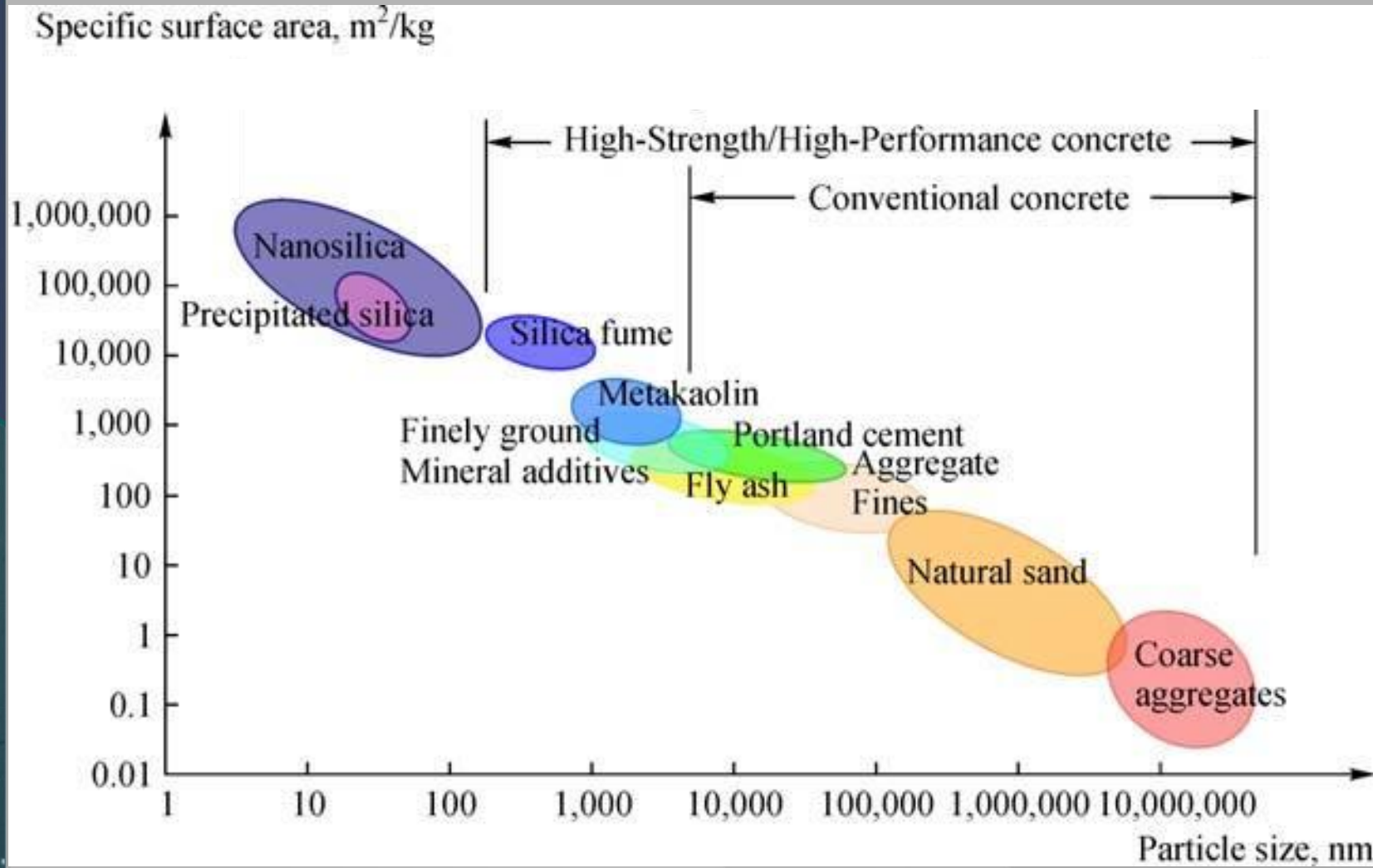



# Specific surface determination

- (sieving)
- gas permeability
  - air permeability (Blaine method)
  - used for cement
- gas adsorption
  - „BET“ method
  - the physical adsorption of gas molecules on a solid surface





# Air permeability method

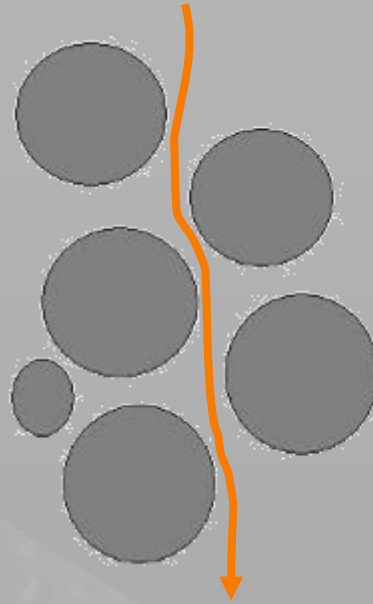

Coarse material

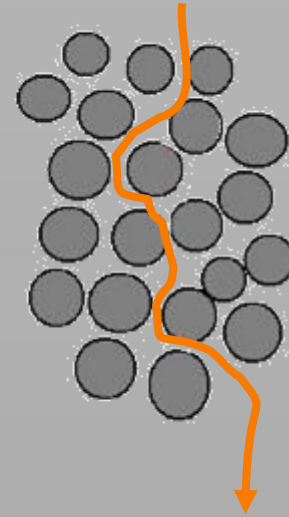

Fine material

- the specific surface is derived from the resistance to flow of air through a porous bed of the powder



# Blain apparatus





# Blain apparatus

Ermittlung der spezifischen Oberfläche von Zement

Determining the specific surface area of cement







# Specific surface calculation

$$S = \frac{K}{\rho} \times \frac{\sqrt{e^3}}{(1 - e)} \times \frac{\sqrt{t}}{\sqrt{0,1\eta}}$$

- **K** apparatus constant
- **e** porosity of the bed (usually  $e = 0,500$ )
- **t** measured time [s]
- **$\rho$**  cement density [ $\text{g.cm}^{-3}$ ]
- **$\eta$**  air viscosity at the test temperature [Pa.s]

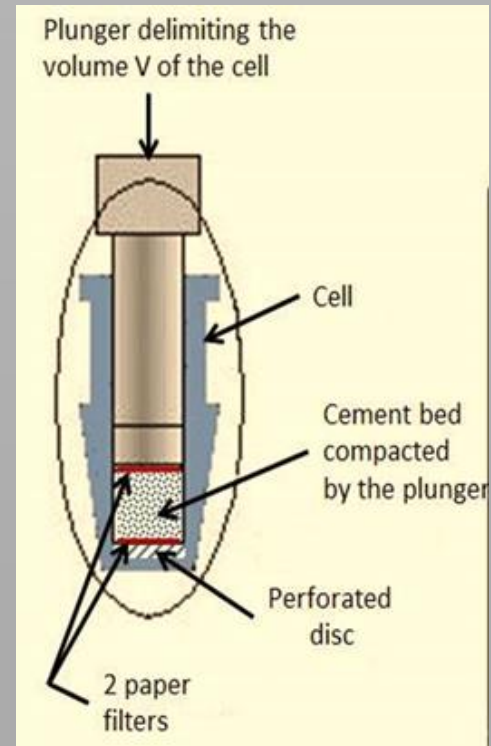



# Apparatus calibration

- apparatus must be calibrated, using a known standard material

$$K = S_0 \times \rho_0 \times \frac{(1 - e)}{\sqrt{e^3}} \times \frac{\sqrt{0,1\eta_0}}{\sqrt{t_0}}$$



- $S_0$  specific surface of the reference cement [ $\text{cm}^2.\text{g}^{-1}$ ]
- $\rho_0$  density of the reference cement [ $\text{g}.\text{cm}^{-3}$ ]
- $t_0$  measured time [s]
- $\eta_0$  air viscosity at the test temperature [Pa.s]



# Fineness of grinding

- cements and similar materials
- described by the specific surface
- finer cement offers a greater surface area for hydration and hence faster the development of strength
- specific surface of common cements:

**250 – 350 m<sup>2</sup>/ kg**

**(2500 - 3500 cm<sup>2</sup>/g)**



**Department of Materials Engineering  
and Chemistry**

**Faculty of Civil Engineering**



## **Building materials**



# Mechanical properties

- **deformation properties** (before destruction)
- **strength properties** (at the moment of break)





# Strength properties





# Strength

- ability to withstand an applied load without failure
- the **maximum stress** sustained by a material loaded to failure





# Strength

According the way of obtaining:

- **theoretical** (structural)
- **technical**
- **statistical**





# Theoretical strength

- Counted from the number and strength of the bonds between atoms

X

- defects in the crystal lattice – real strength is distinctively lower (ca 1000x)

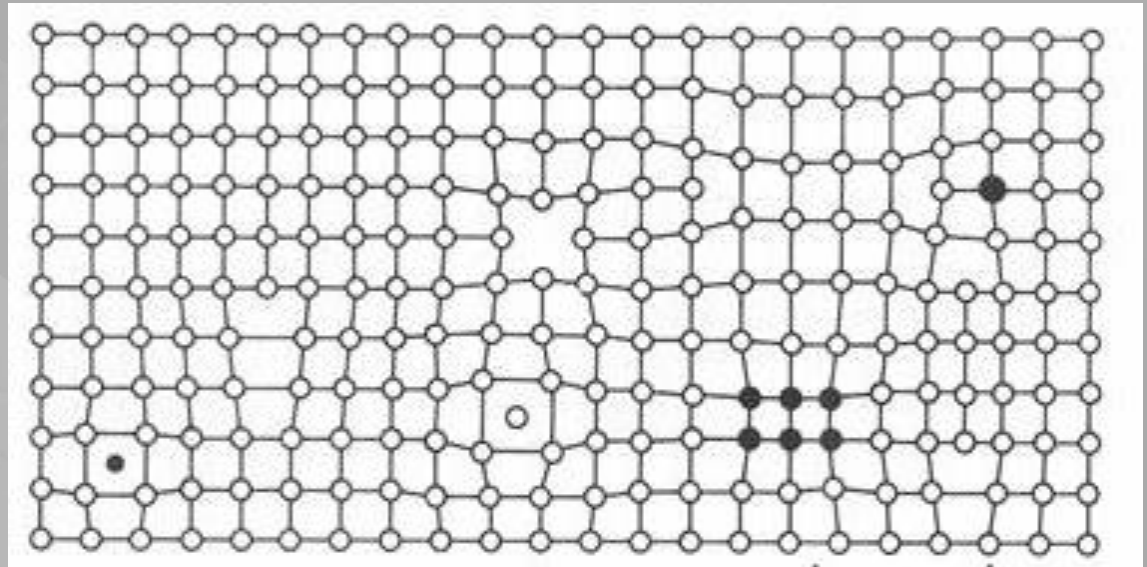



# Technical strength

- from the testing of the real material sample
  - material have to be homogenous
  - test samples in the appropriate shape (cylinder strength, cubic strength...)



# Test samples

- shaping from the material
  - cutting, carving, drilling
- directly made in the required shape
  - cubes, cylinders..
- whole products
  - bricks, blocks





# Statistical strength

- from the single samples properties the property of the whole population can be estimated by the **statistical methods**

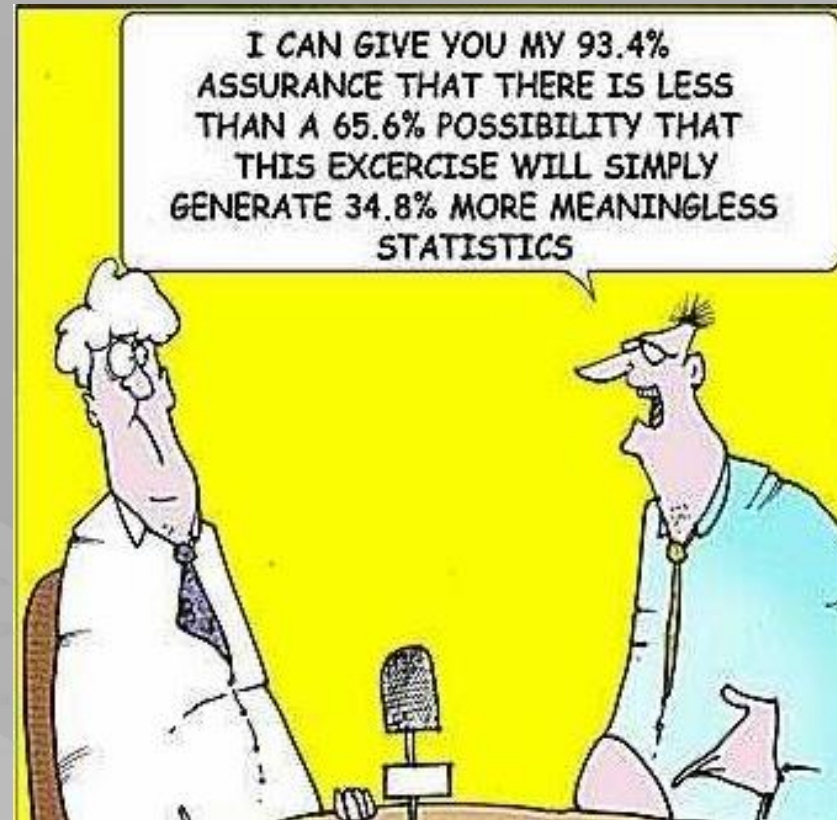



# Statistics

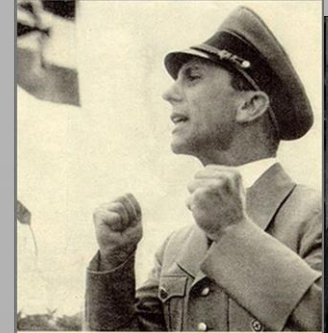

Dr. Josef Goebbels  
Reich Minister of Propaganda

„ The only statistics you can trust are those you falsified yourself.“

attributed to *Winston Churchill*



# Statistics - glossary

- **Random experiment** - an experiment whose outcome is not perfectly predictable
- **Population** - the entire collection of items that is the focus of concern
- **Random sample** - a sample whose members are chosen at random from a given population in such a way that the chance of obtaining any particular sample can be computed



# Statistical evaluation of strength

- Only part of the population is tested – **random sample**
- From the results of random sample can be estimated a corresponding parameter of the population
- Typical population has **normal distribution** (Gaussian function)



# Normal distribution

- for the whole population

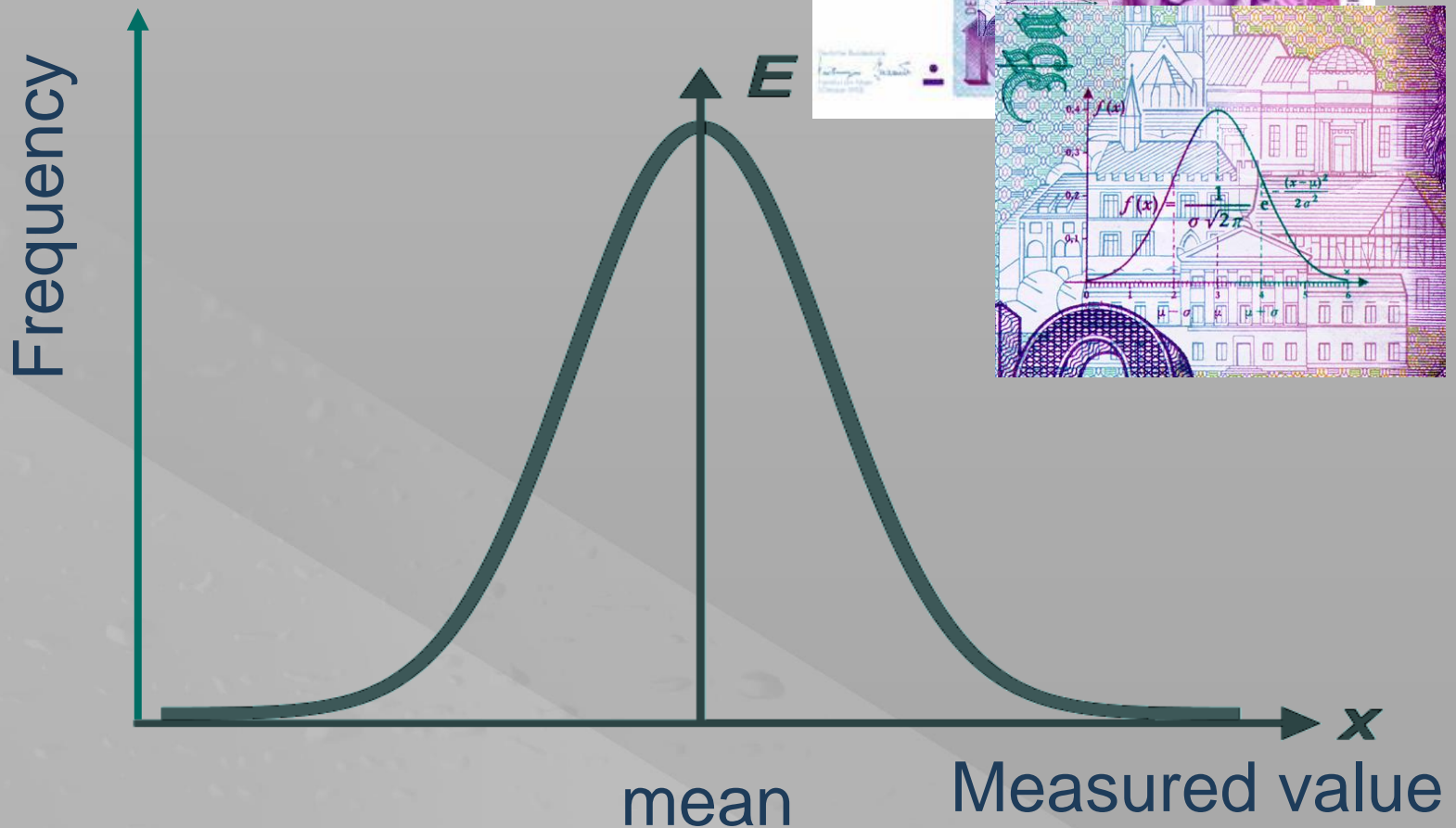





# Gaussian curve

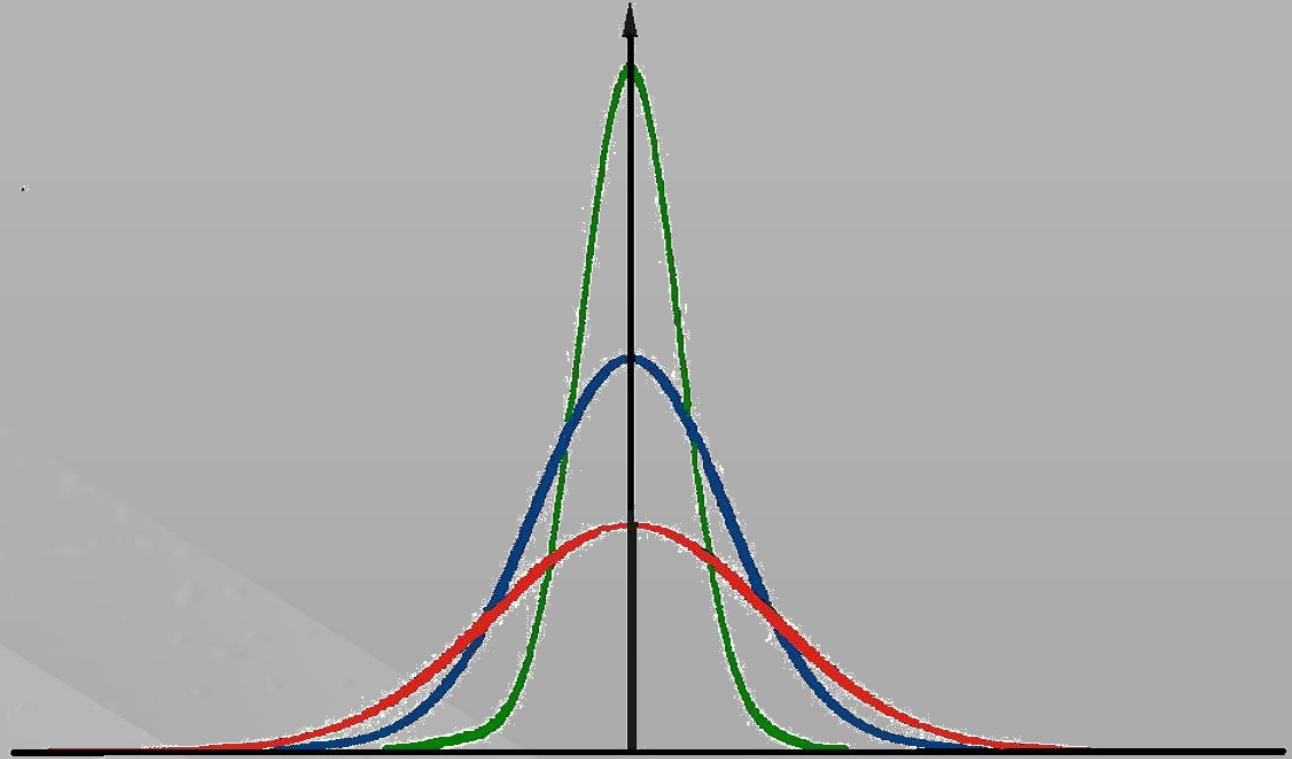

- the narrower and higher the curve is, the more statistically homogenous the data



# Histogramme

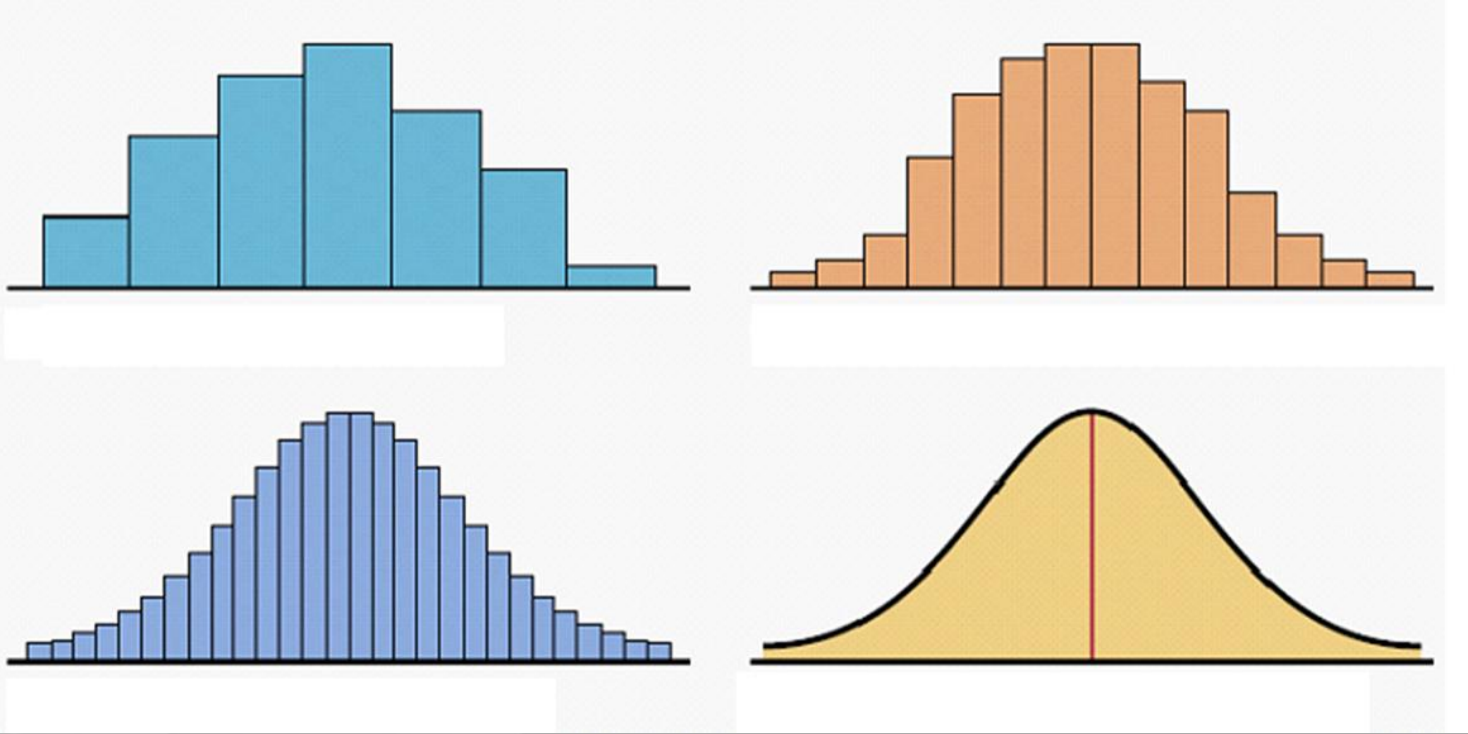

- from testing of random sample the distribution curve could not be made
- the more numerous the random sample is, the closer to the curve the histogram is



# Normal and other distribution

- normal distribution
- non-symmetrical

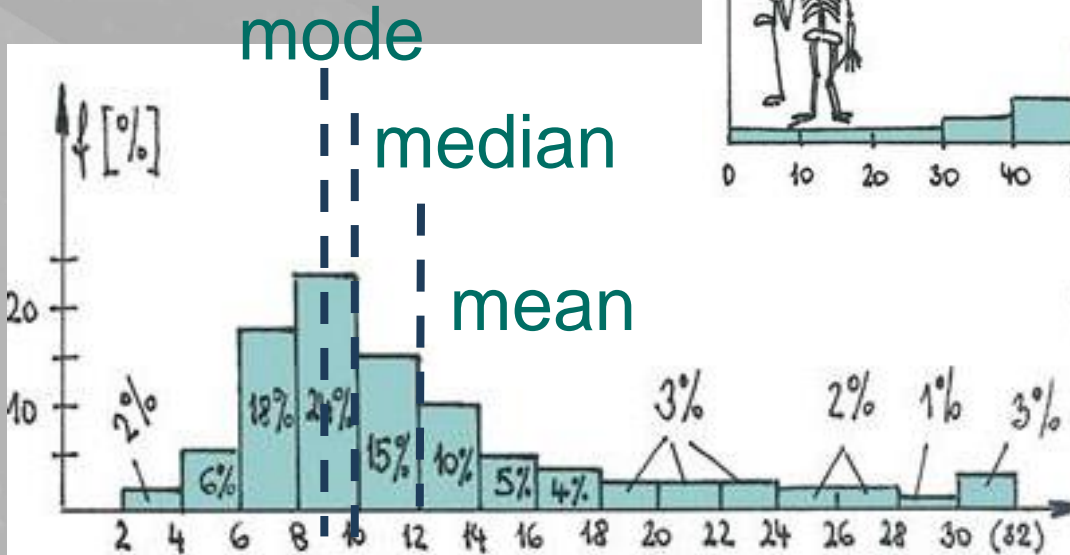
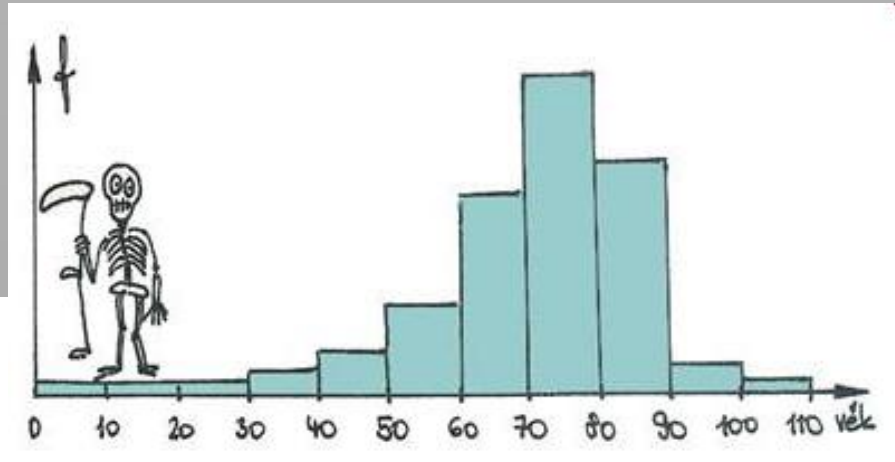
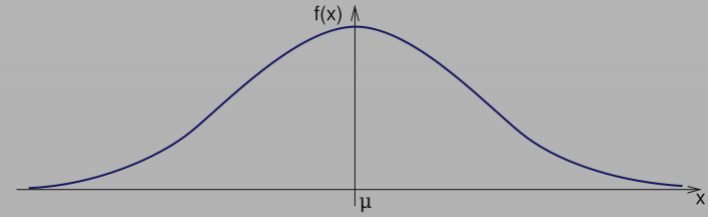

wage



# Statistical parameters

Values:	4, 8, 6	2, 5, 11
• <b>Mean</b>	$\bar{x} = 6$	$\bar{x} = 6$
Deviations	-2, +2, 0	-4, -1, +5
Sum of deviations	0	0
Deviations square	4, 4, 0	16, 1, 25
Sum of squares	8	42
• <b>Variance</b>	<b>2.67</b>	<b>14</b>
• <b>Standard deviation</b>	<b>1.63</b>	<b>3.74</b>



# Statistical parameters

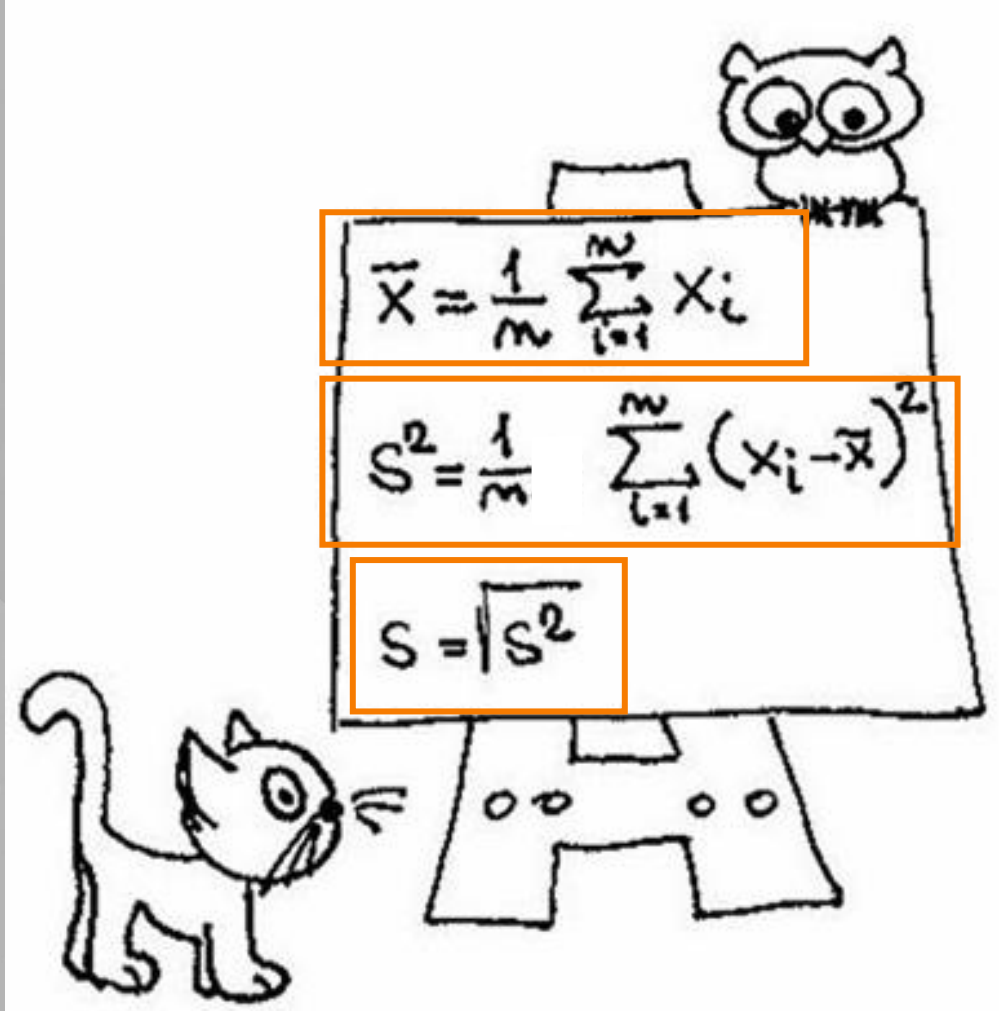

mean

variance

standard  
deviation



# Standard deviation $s$

- measure of variability or diversity of a data set

- low standard deviation

- the data points tend to be very close to the mean

- high standard deviation

- the data points are spread out over a large range of values

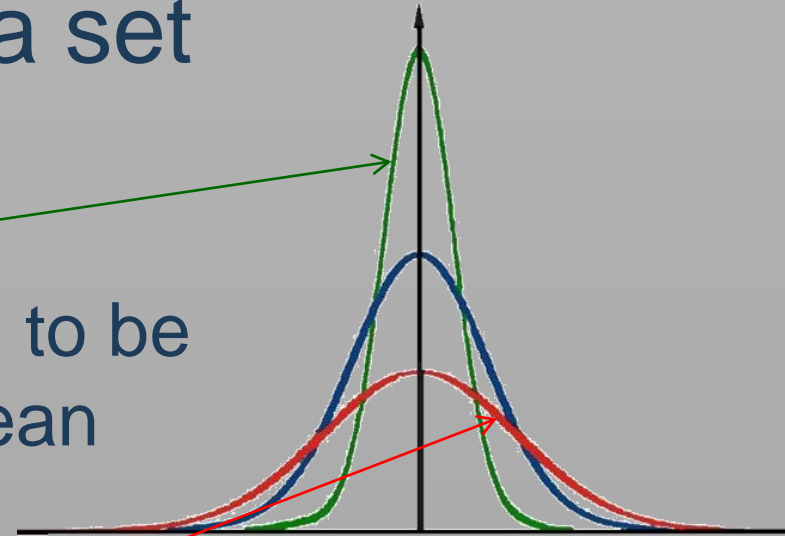



# Normal distribution

- symmetrical
- $+s$  to  $-s$  : 68.26 % of area
- $+2s$  to  $-2s$  : 95.6 % of area
- $+3s$  to  $-3s$  : 99.7 % of area

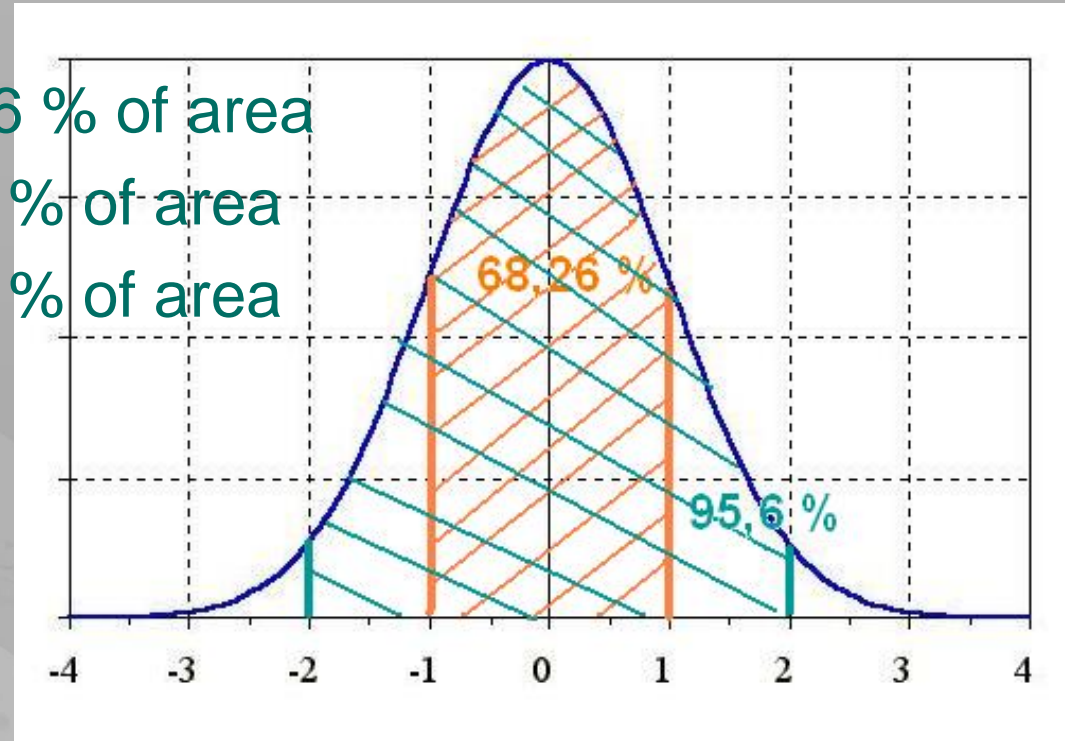



# Guaranteed value

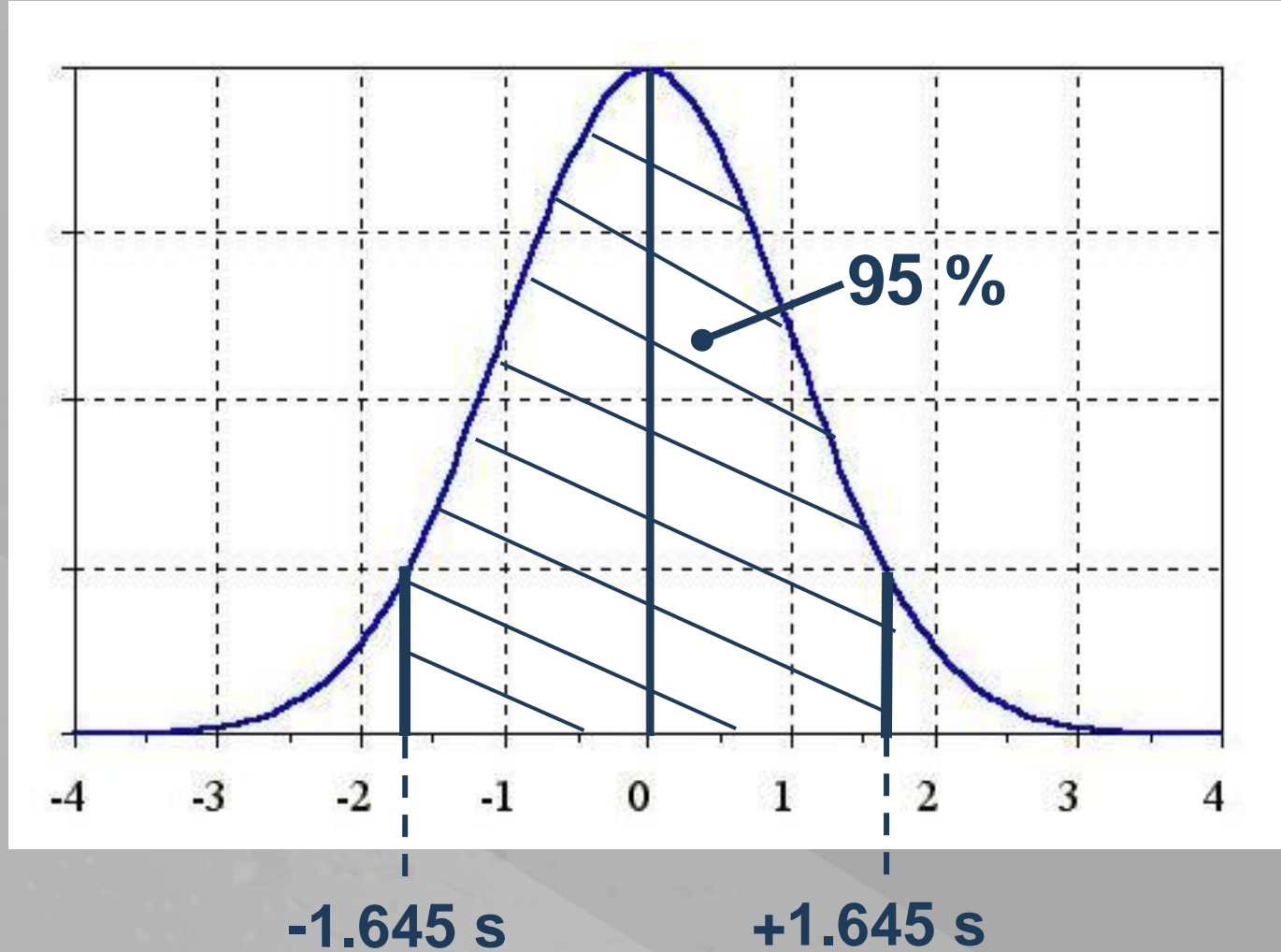





# Guaranteed strength

- the value of the strength, for which can be statistically guaranteed, that 95 % of whole production will have the same or higher value of the strength

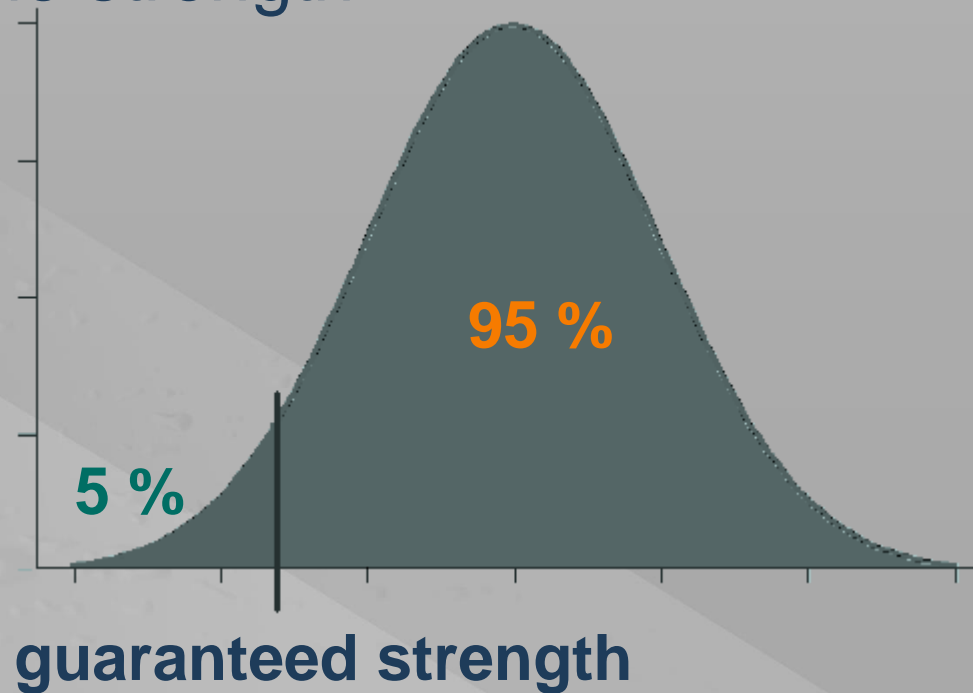

**Department of Materials Engineering  
and Chemistry**

**Faculty of Civil Engineering**



**Building materials**



# Technical strength determination

- by testing
- according to the loading



compression



tension

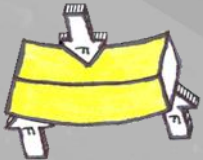

bending



torsion



shear

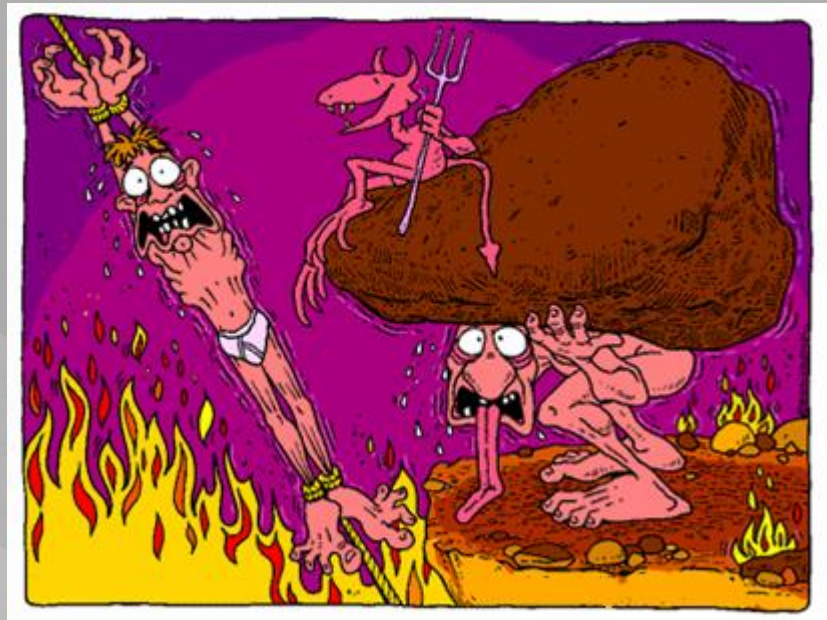



# Compressive strength

- maximum resistance of a material to axial compressive loading

$$R_c = \frac{F_{max}}{A} \quad [\text{MPa}]$$

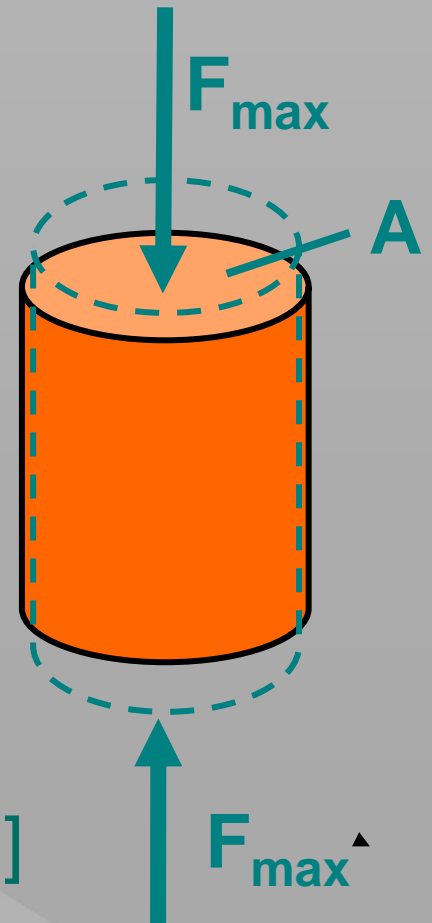

$F_{max}$  ....

maximum force [N]

$A$  .....

compressed area  
(cross-sectional) [mm<sup>2</sup>]



# Compressive strength - testing

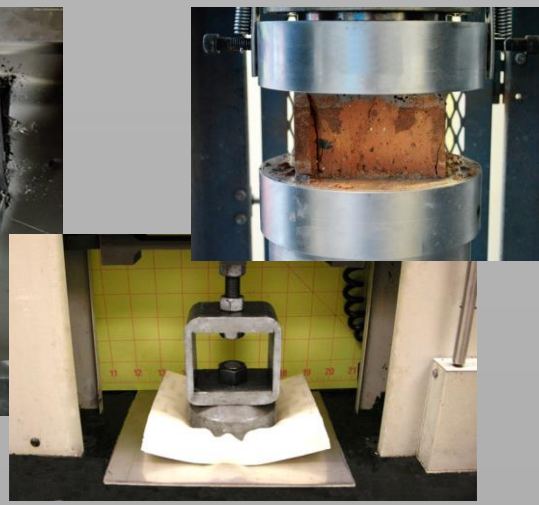
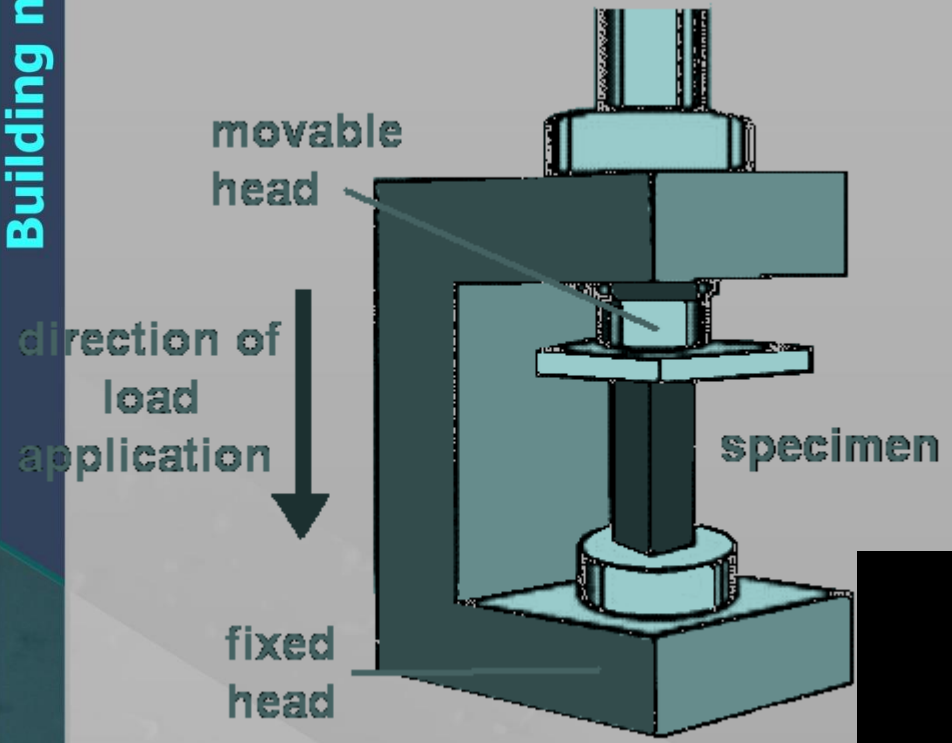



# Test specimen for compressive test

Regular shape:

- **cubes** (concrete)
- **cylinders** (concrete, lightweight concretes)
- **beams** (lightweight concretes)
- **prism halves** (cement)
- **whole product** (block, brick)





# Test specimen for compressive test

- irregular shape
  - **auxiliary plates**
- compressed area **A** given by the area of plates

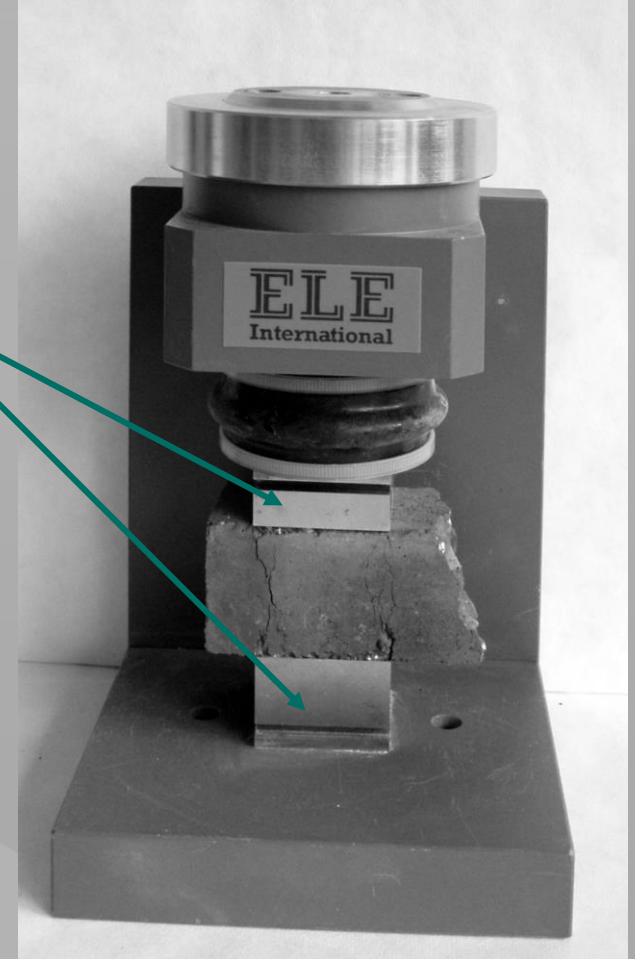



# Compressive strength

## Concrete C 25/30

cylinder strength < cube strength

- the influence of friction between material surface and testing machine decreases with the height of the sample



Cylinder Strength		Cube Strength	
MPa	Psi	MPa	Psi
12	1740	15	2175
16	2320	20	2900
20	2900	25	3625
25	3625	30	4350
30	4350	37	5365
35	5075	45	6525
50	7250	60	8700







# Compressive strength of building materials

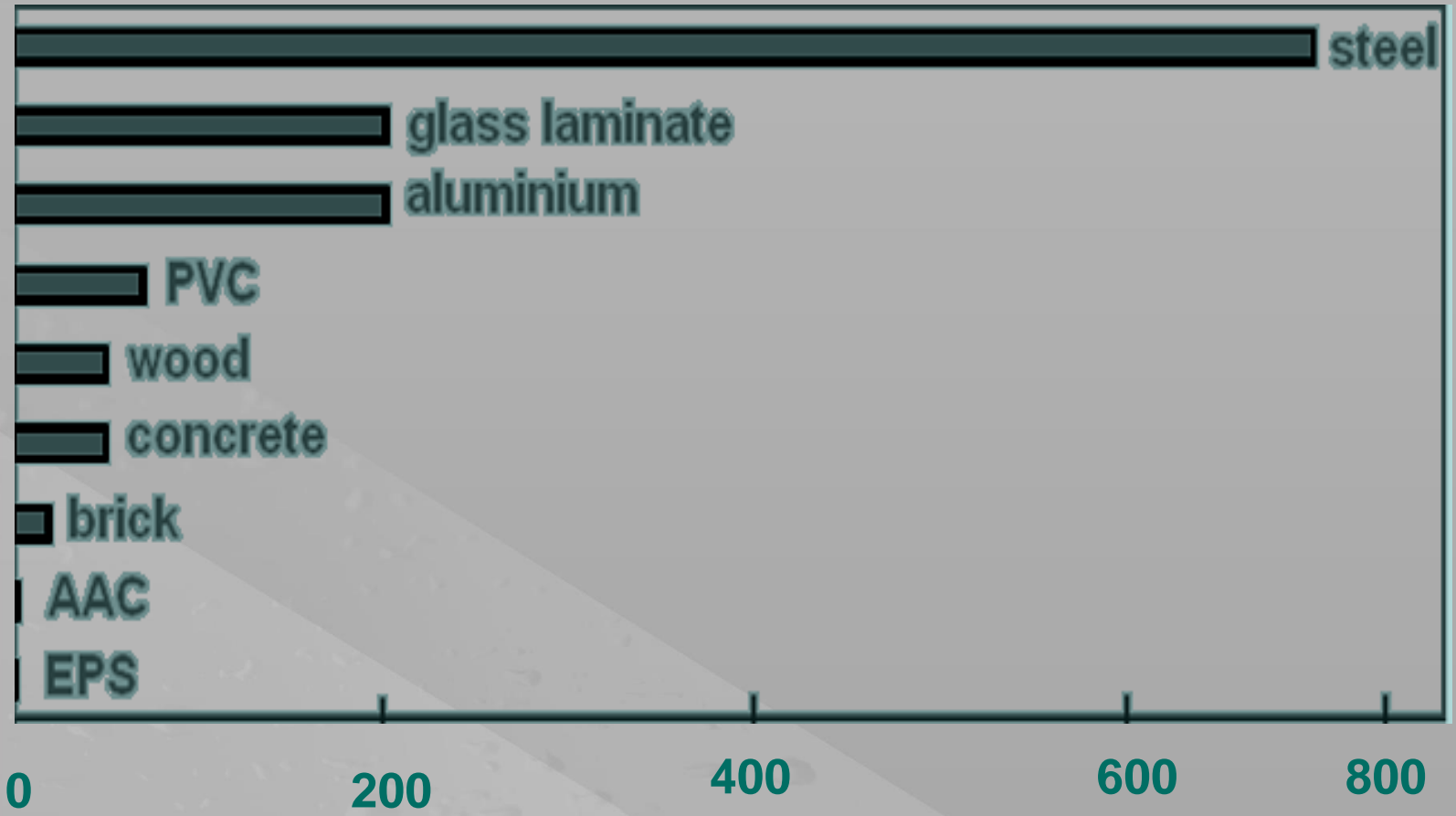



# Tensile strength

$$R_t = \frac{F_{\max}}{A} \quad [\text{MPa}]$$

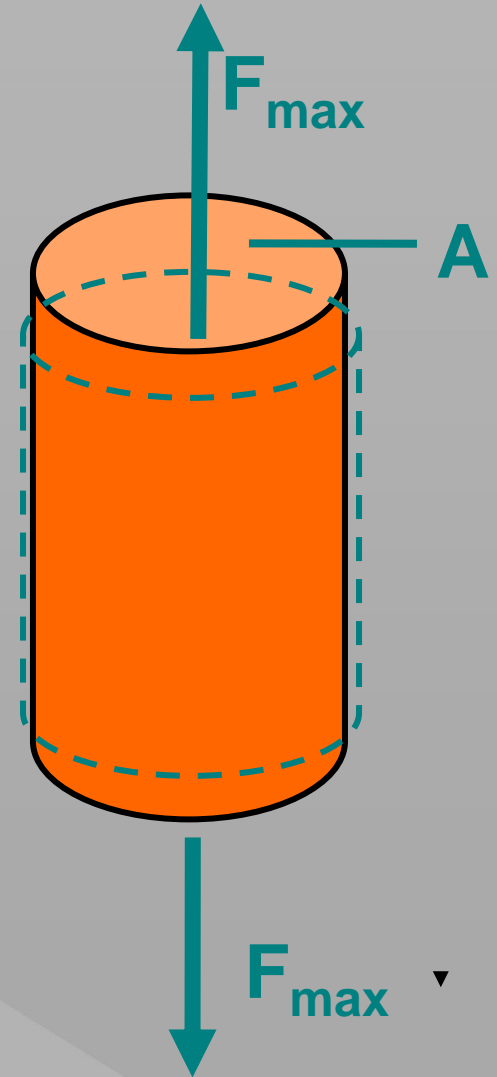

$F_{\max}$  .... maximum force [ N ]

$A$  ..... area [mm]



# Tensile strength - testing

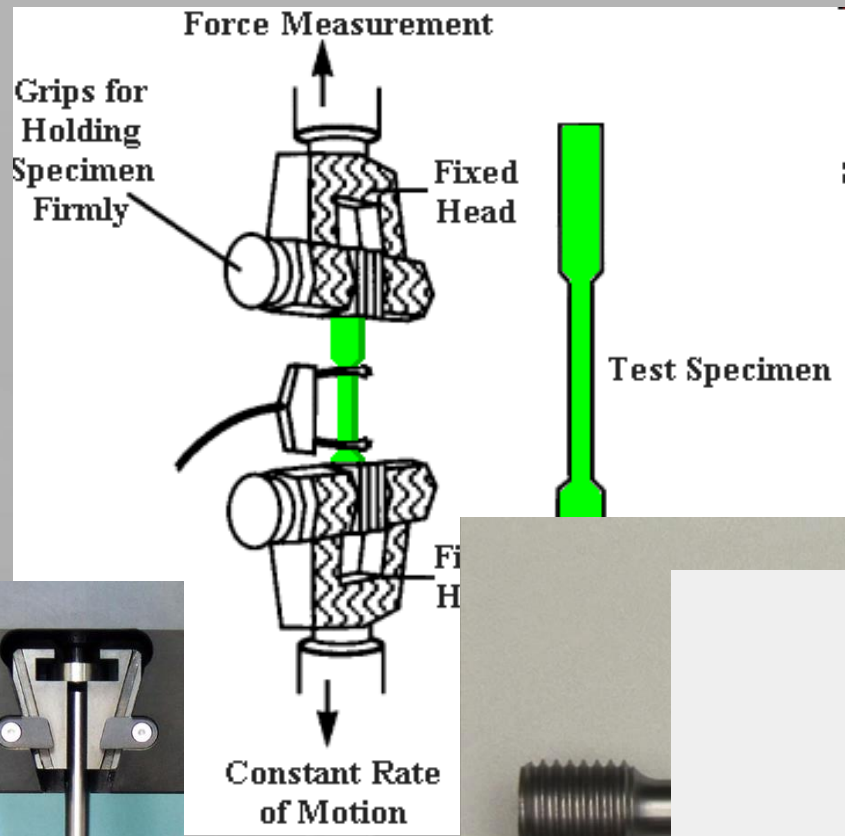

Foam Tensile Strength Test  
ASTM D3574 Test E





# Test specimen for tensile test

- round or flat, slim
- special shoulders for gripping in the machine

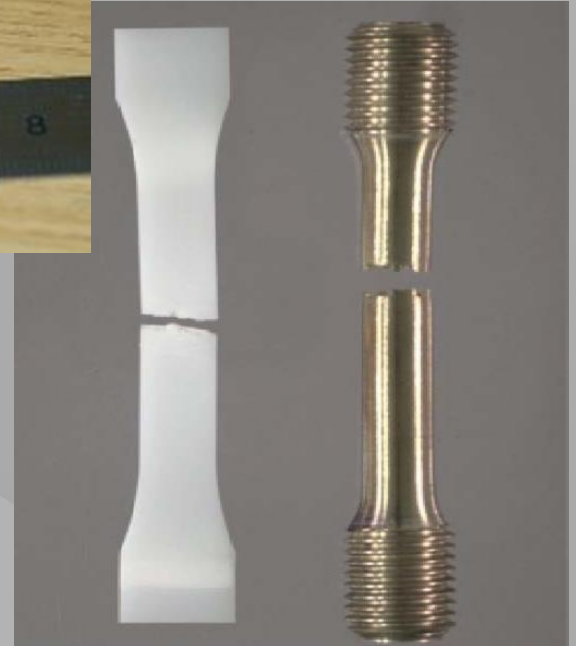
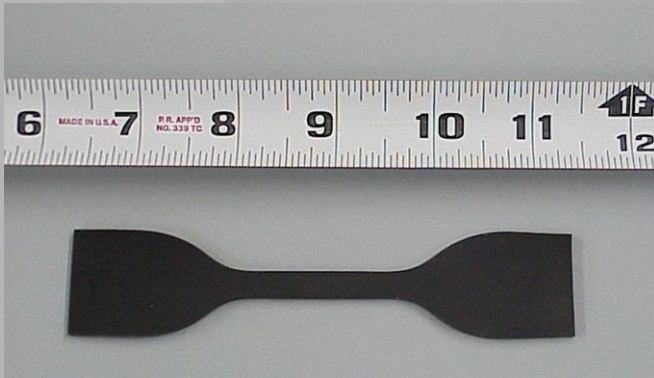



# Flexural strength

- tensile strength of materials with distinctively higher compressive strength than tensile strength
- fracture in the place of the maximum bending moment

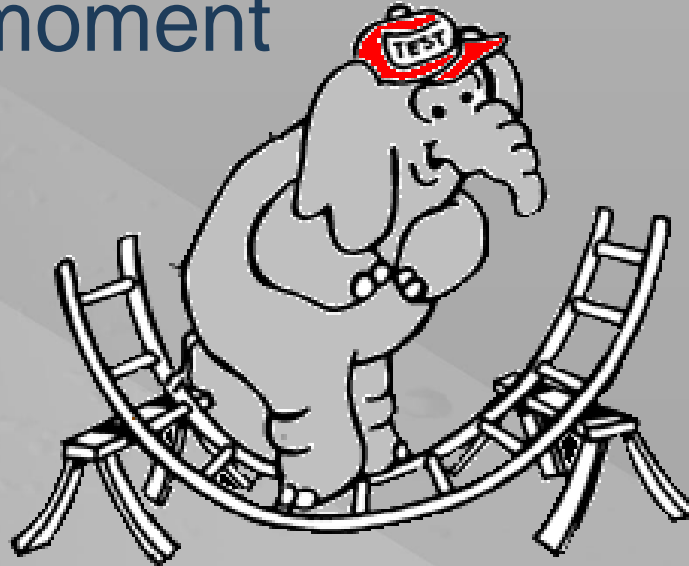



# Flexural strength

$$R_y = \frac{M_{\max}}{W}$$

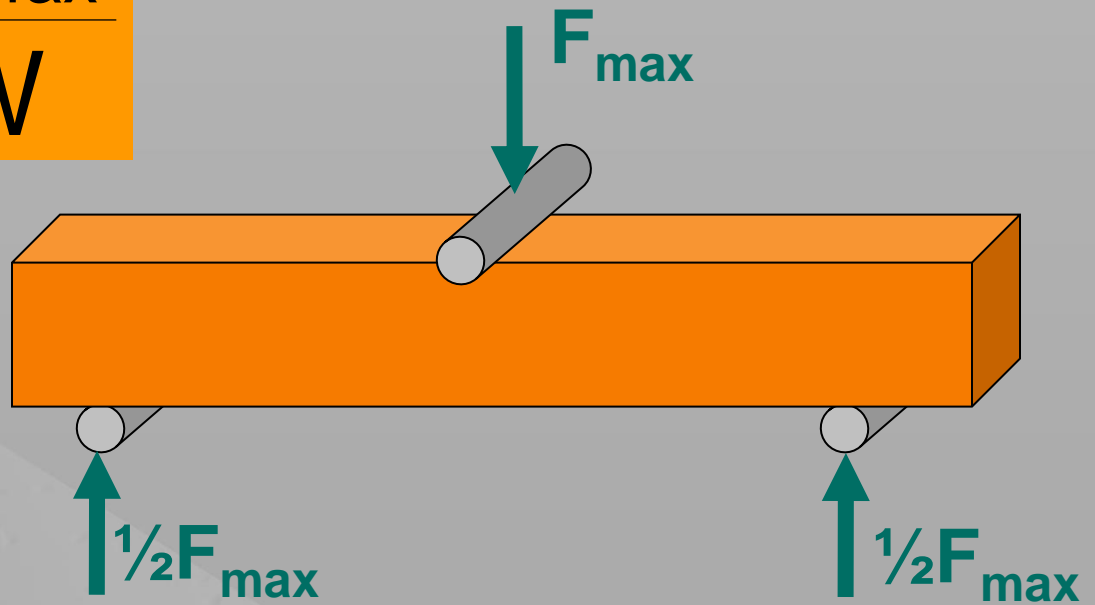

$M_{\max}$  ... maximum bending moment [N.mm]

$W$  ... section modulus [mm<sup>3</sup>]



# Flexural strength

- **bending moment  $M$**   
according type of loading  
(three point test, four point test)

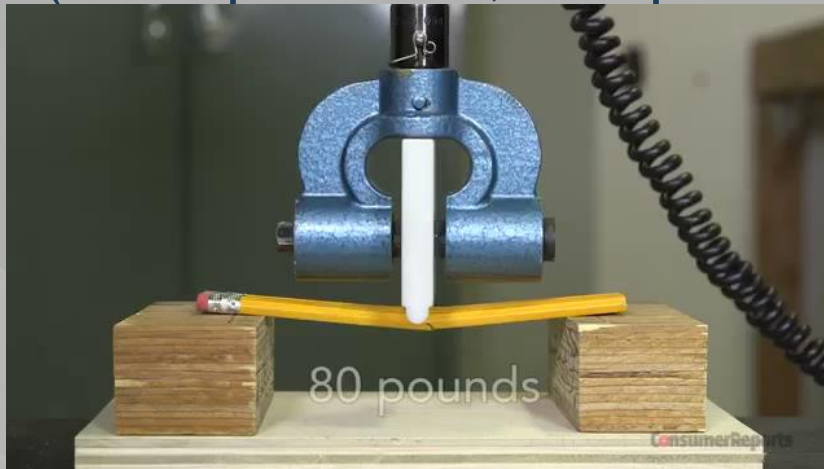

- **section modulus  $W$**   
according the shape and  
size of cross section

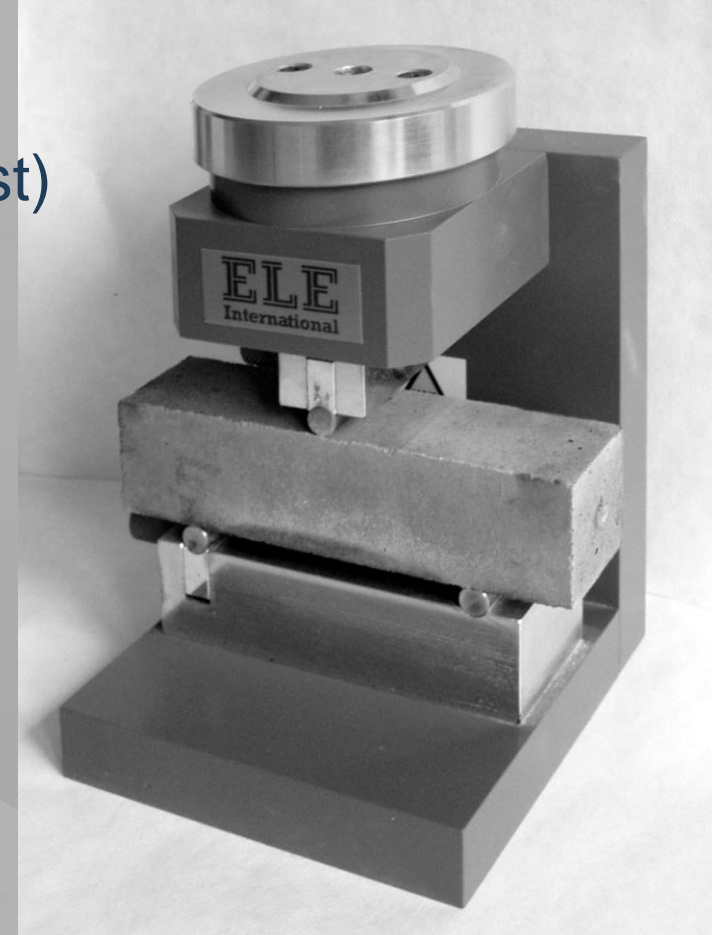

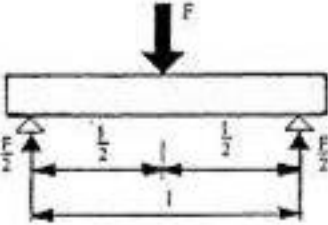
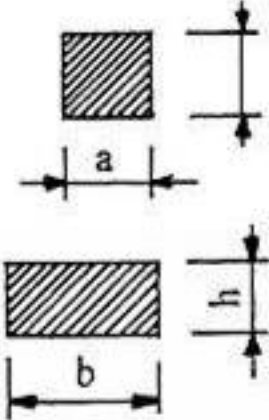
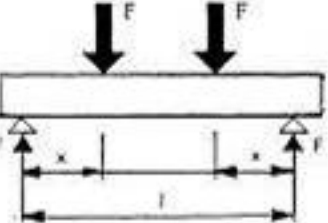
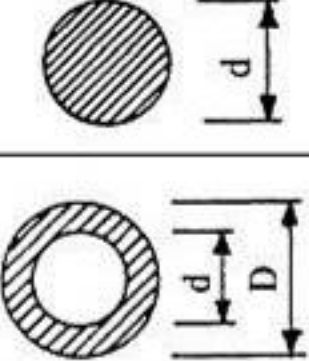

# Calculation of M and W

Loading diagram	Bending moment	Shape of cross-section	Section modulus
	$M = \frac{1}{4} F \times l$		$W = \frac{1}{6} a^3$ $W = \frac{1}{6} bh^2$
	$M = F \times l$		$W = \frac{\pi}{32} d^3 = 0,1d^3$ $W = \frac{\pi(D^4 - d^4)}{32D}$





# Splitting tensile strength

- fragile materials

$$R_t = \frac{2F_{\max}}{\pi \cdot D \cdot l}$$

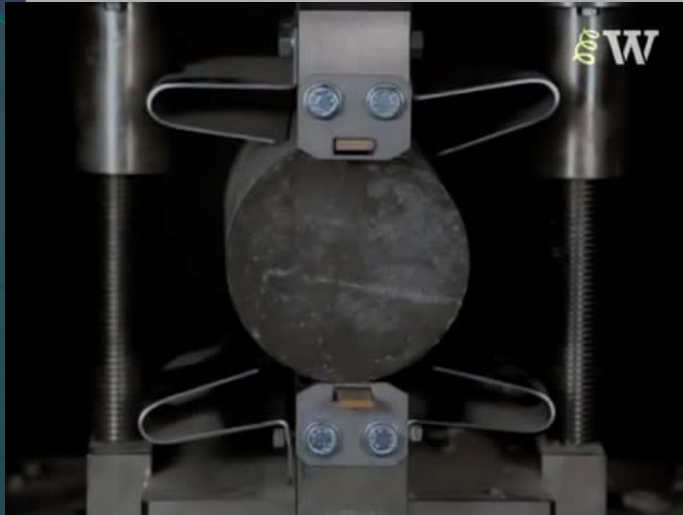
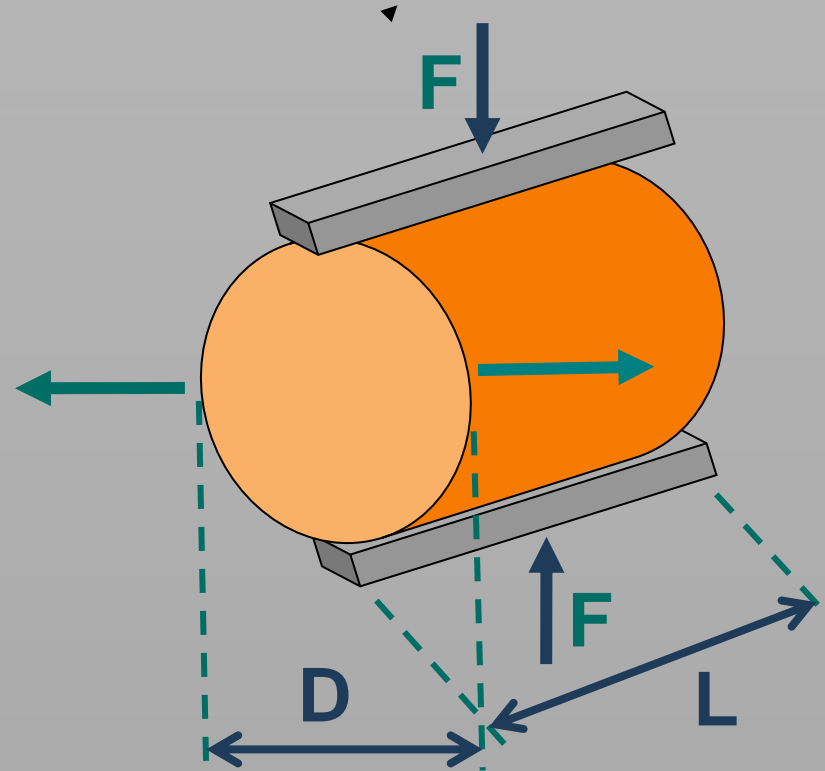



# Brazilian test

- stones



Rock	Compressive strength	Tensile strength
basalt	250 - 350	8
granite	80 - 280	3 - 8
limestone	40 - 200	1 - 6
sandstone	40 - 180	1.5 - 3
schist	60 - 200	2.5
marble	80 - 150	3 - 9
quartzite	300 - 500	3 - 5



# STRENGTH DETERMINATION

**COMPRESSION:**

<b>CYLINDER:</b>	<b>CUBE:</b>	<b>PRISM:</b>	<b>PRISM HALVE:</b>
$R_c = \frac{F_{max}}{A}$ $A = \frac{\pi \cdot d^2}{4}$	$A = a_1 \cdot a_2$	$A = a_1 \cdot a_2$	$A = a \cdot b$

**TENSION:**

$A = \frac{\pi \cdot d^2}{4}$

$R_t = \frac{F_{max}}{A}$

**FLEXURE:**

$R_f = \frac{3 \cdot F_{max} \cdot l}{2 \cdot b \cdot h^2}$

**SPLITTING:**

$R_t = \frac{2 \cdot F_{max}}{\pi \cdot d \cdot l}$	$R_t = \frac{2 \cdot F_{max}}{\pi \cdot a^2}$	$R_t = \frac{2 \cdot F_{max}}{\pi \cdot b \cdot h}$

**SHEAR:**

$R_s = \frac{F_{max}}{A}$	$A = b \cdot h$
$R_s = \frac{F_{max}}{2A}$	

**Department of Materials Engineering  
and Chemistry**

**Faculty of Civil Engineering**



**Building materials**



# Deformation properties



# Deformation properties

- describe the behavior of the materials before the fracture

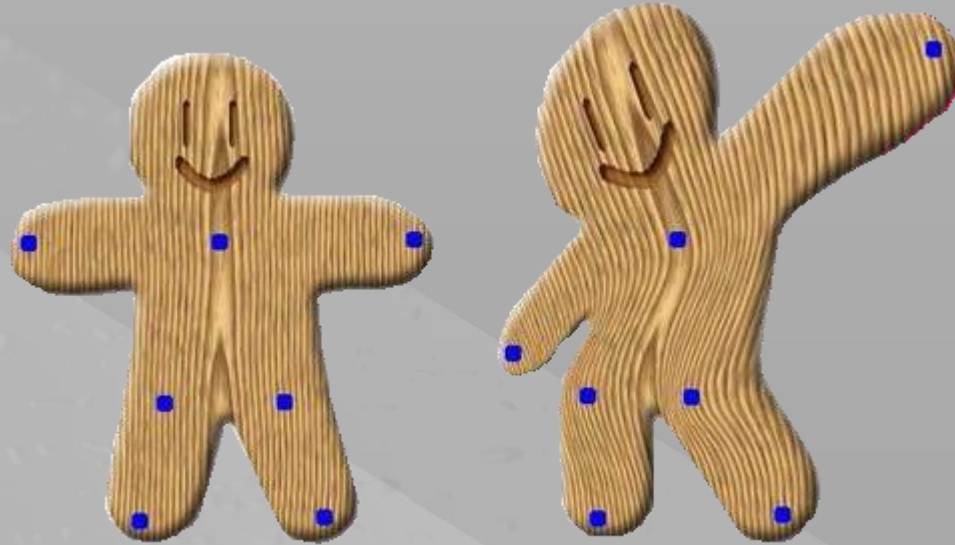



# Deformation

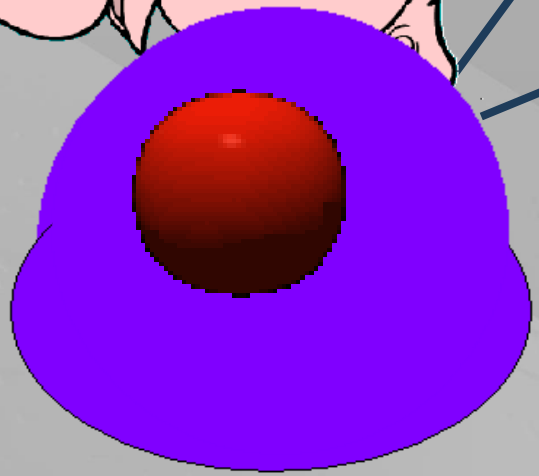
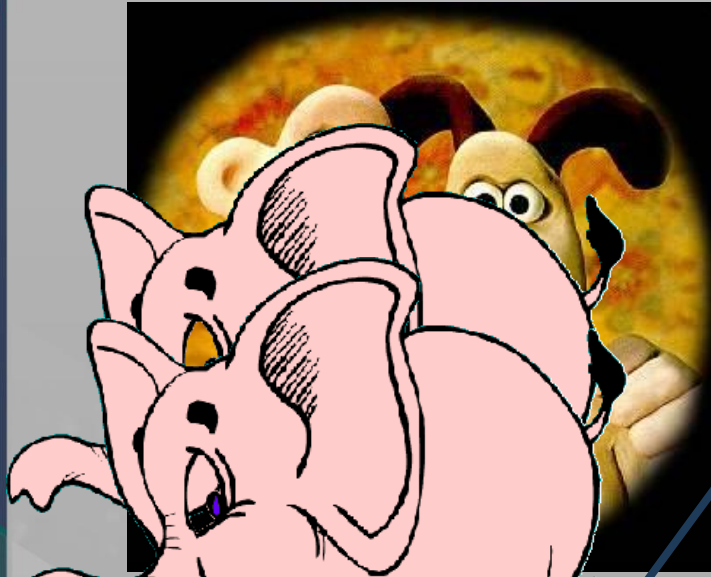

Irreversible deformation - plastic

Reversible deformation - elastic





# Stress-strain diagram

- graphical representation of the relationship between **stress**, derived from measuring the **load** applied on the sample, and **strain**, derived from measuring the **deformation** of the sample (elongation, compression, or distortion)





# Stress strain diagram

- the relationship between stress ( $\sigma$ ) and strain ( $\epsilon$ ) (load  $F$  and deformation  $\Delta l$ )

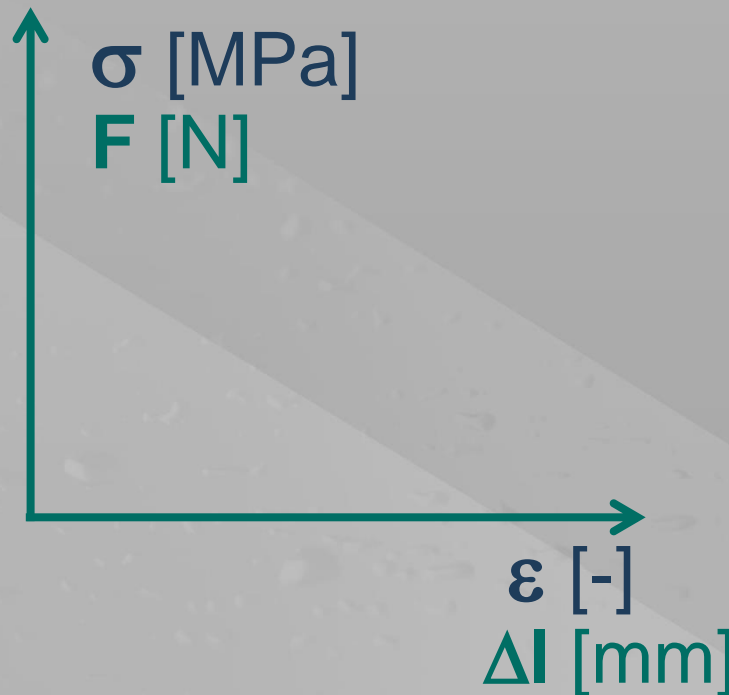

- deformations
- yield strength
- ultimate strength
- toughness
- Young modulus



# Stress-strain diagram

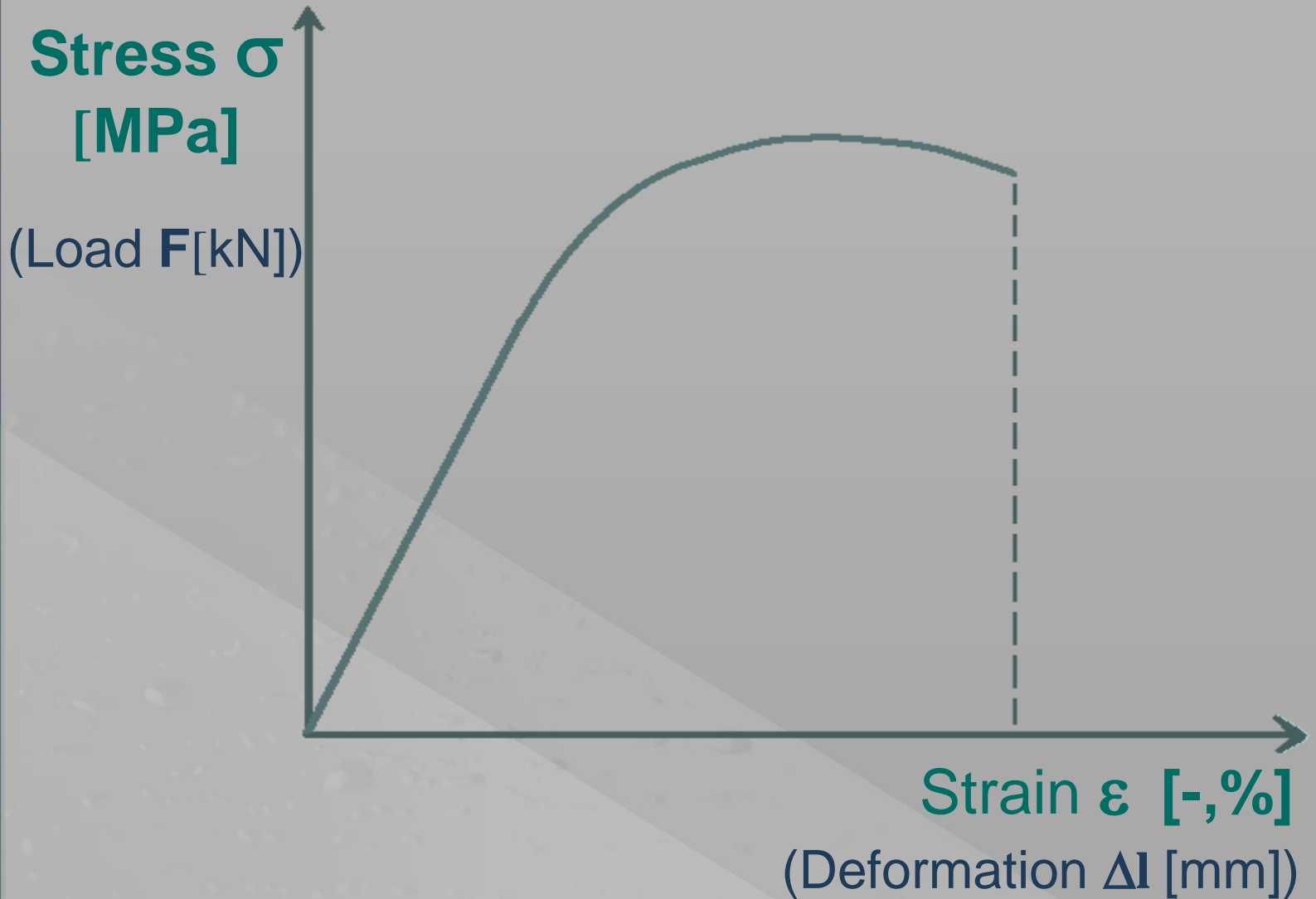



# Stress-strain curves

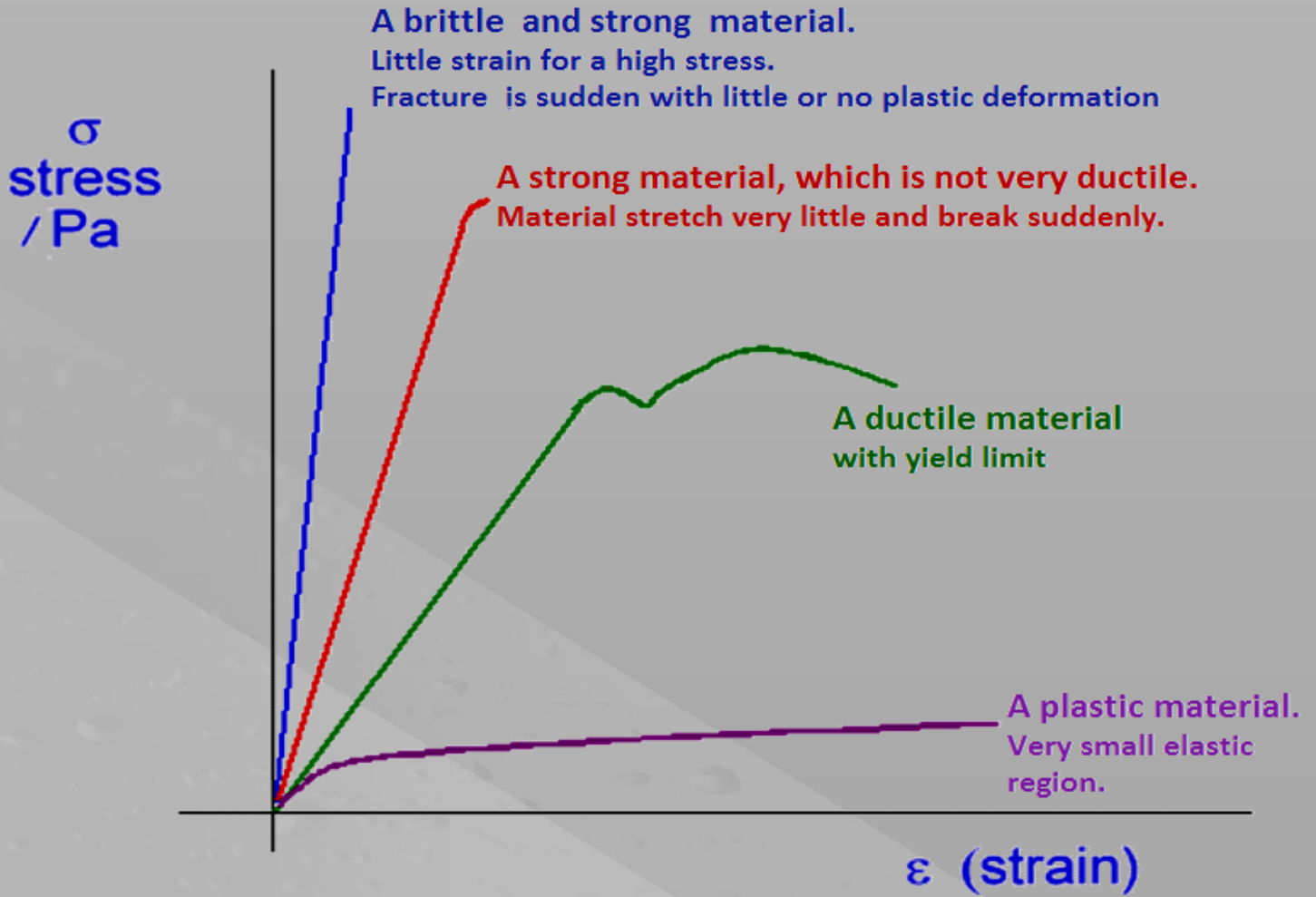



# Stress-strain curves of different materials

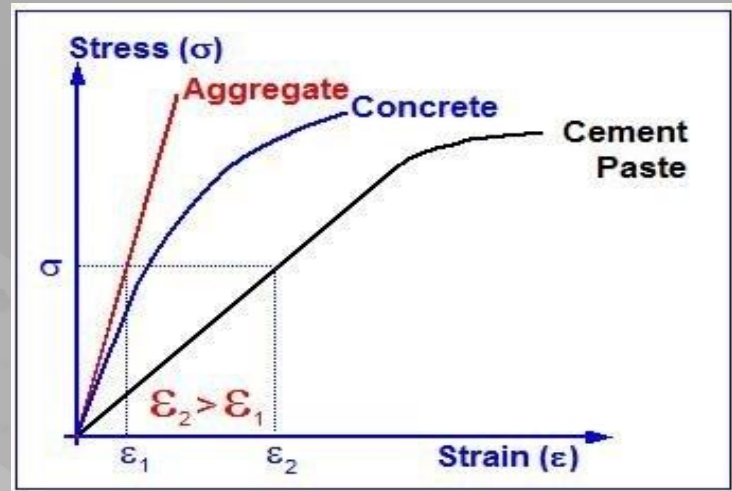
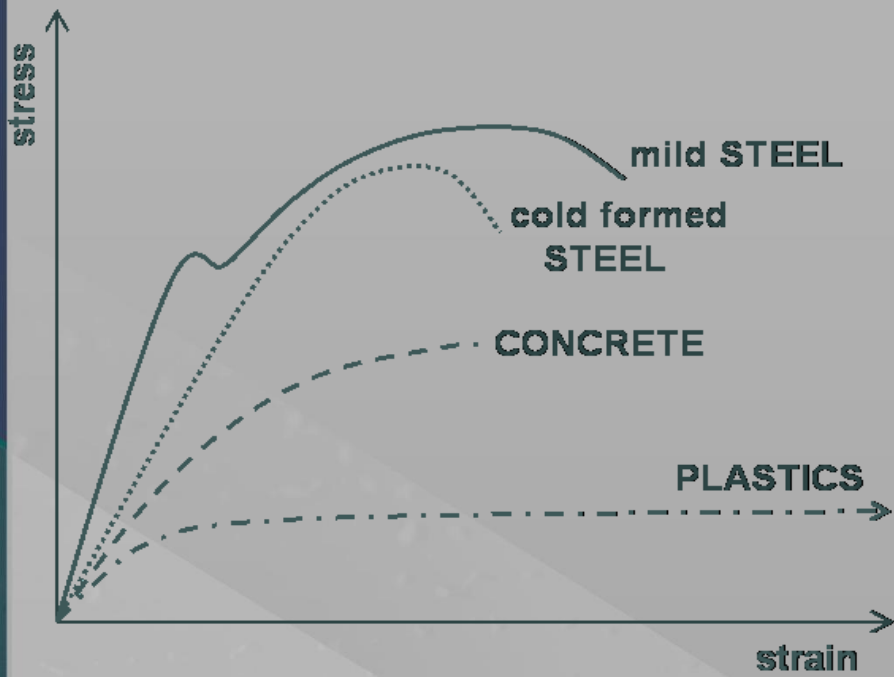



# Typical stress-strain curve for ductile material

stress

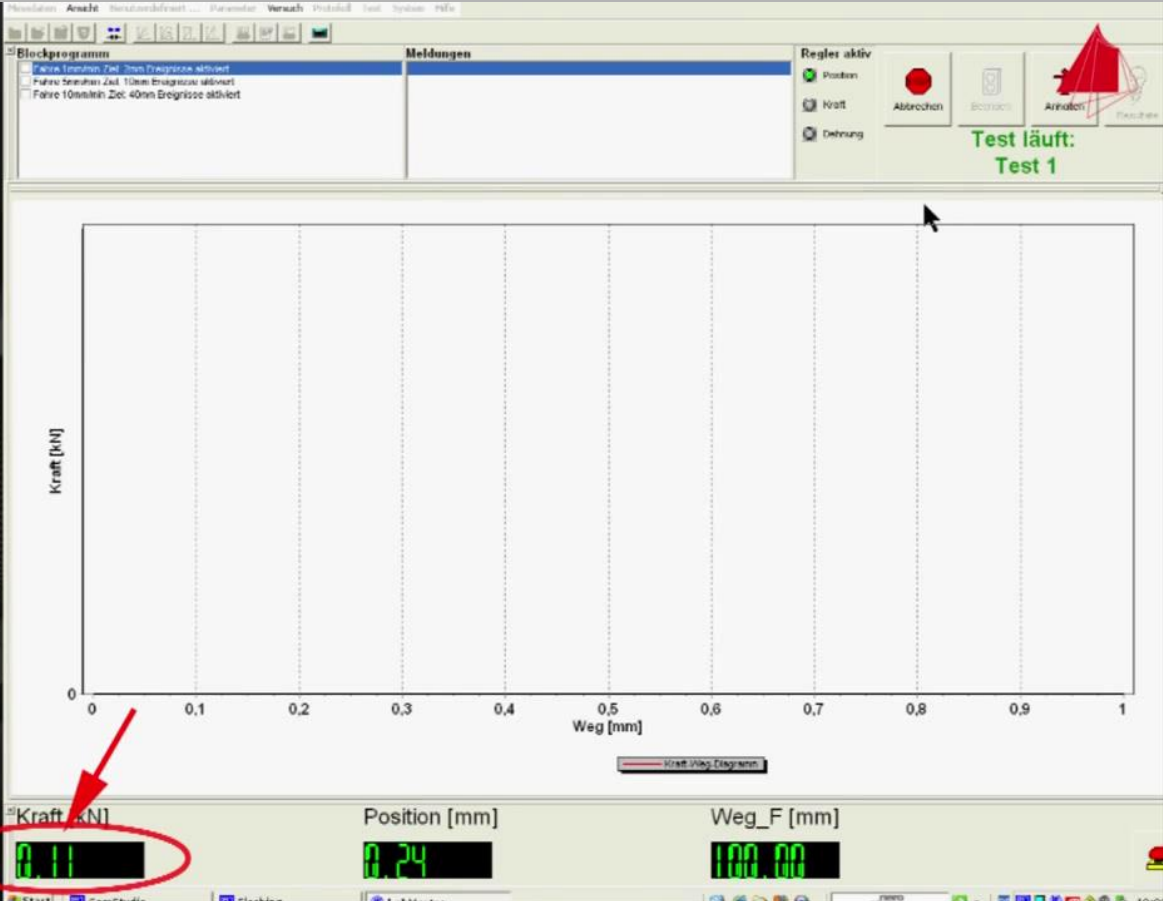
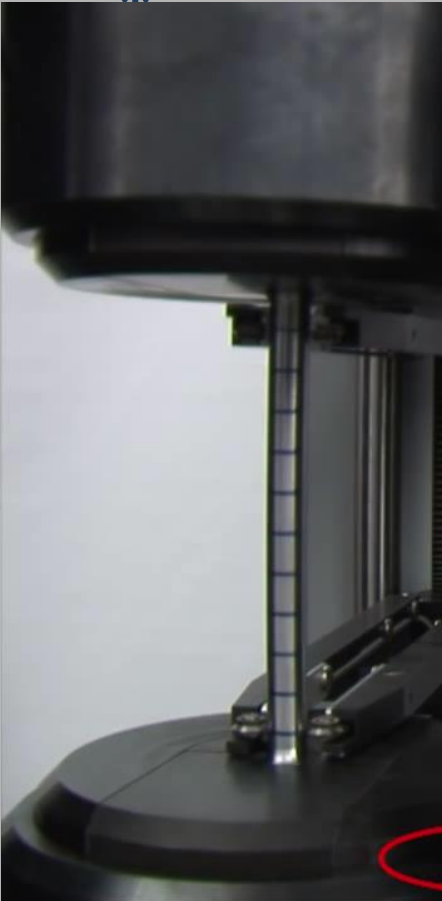

strain



**Department of Materials Engineering  
and Chemistry**

**Faculty of Civil Engineering**



**Building materials**



# Modulus of elasticity

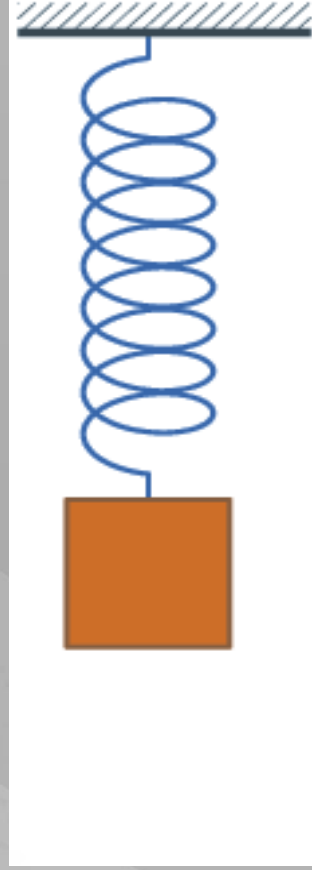



# Elastic behavior of materials describes

## Hooke's Law :

$$\sigma = E \cdot \varepsilon$$

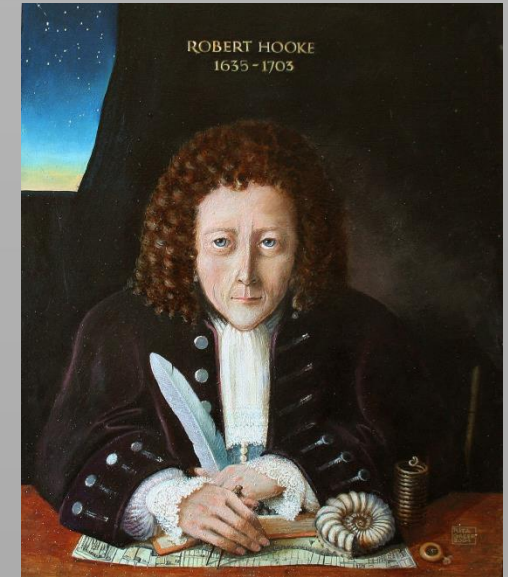

Robert Hooke  
1635-1703

$\varepsilon$  ... strain [unitless]

$\sigma$  ... stress [MPa]

$E$  ... modulus of elasticity [MPa]  
(Young's modulus)





# Elastic modulus

$$E = \frac{\sigma}{\varepsilon_{el}}$$

- the mathematical description of a material's tendency to be deformed elastically when a force is applied to it
- Hooke's law is valid only for **elastic range of material**



# Elastic modulus

tension or compression – Young's modulus

$$E = \frac{\sigma}{\epsilon_{el}}$$



Thomas Young (1773-1829)

shear – modulus of rigidity or shear modulus

$$G = \frac{\tau}{\gamma}$$



# Deformation

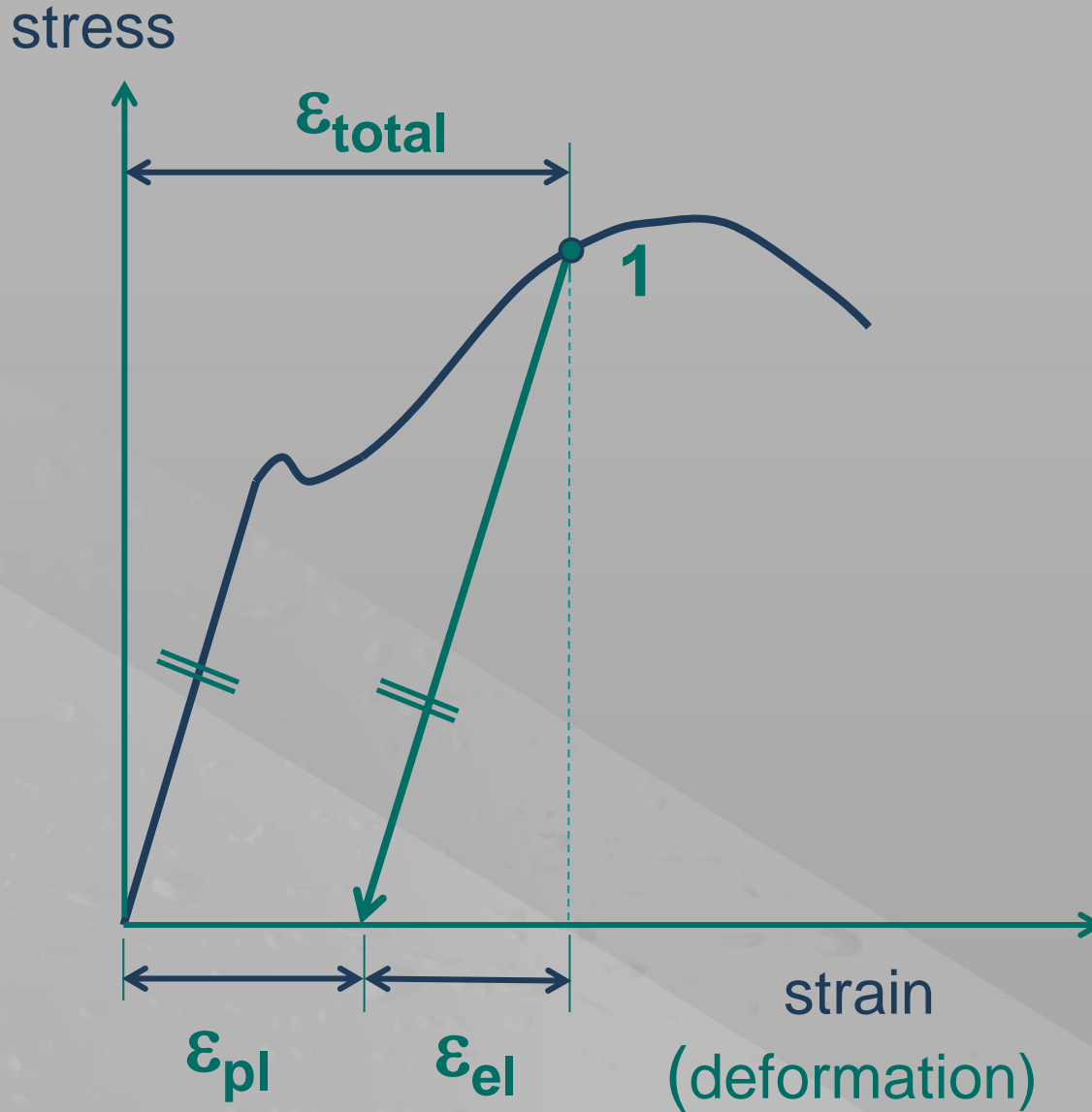

$\epsilon_{total}$  - total deformation

$\epsilon_{el}$  - elastic deformation

$\epsilon_{pl}$  - plastic deformation



# Graphical determination of Young's Modulus

$$E = \frac{\sigma}{\epsilon_{el}}$$

$$E = \operatorname{tg} \alpha$$

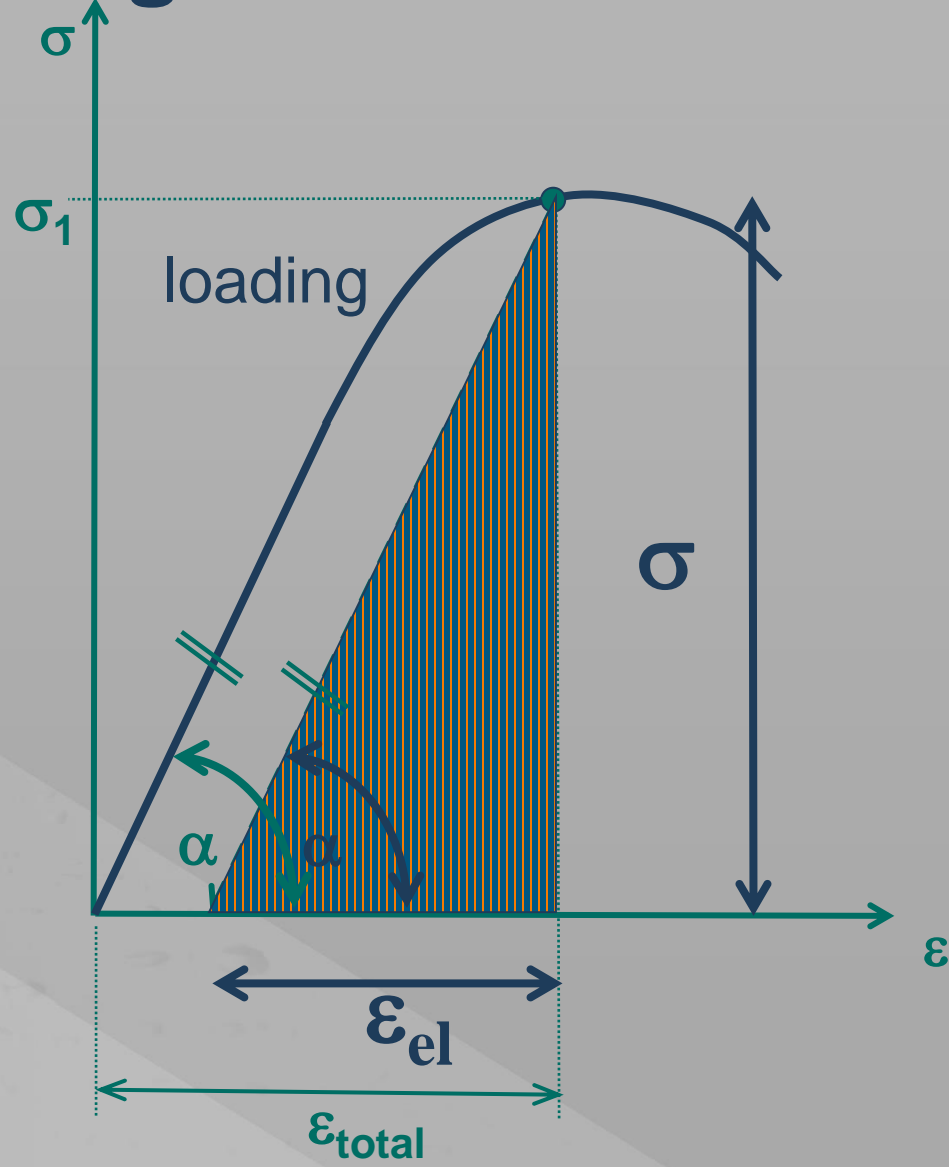

statical

$$E = \frac{\sigma}{\varepsilon_{el}}$$

$\sigma$  ..... stress [MPa]

$\varepsilon$  ..... strain [-]

# Young's modulus determination



# Young's modulus determination

## Stress $\sigma$ :

- according the type of loading

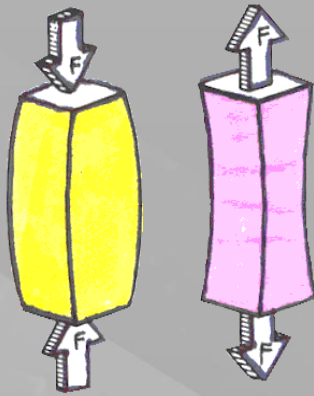

compression  
tension

$$\sigma = \frac{F}{A}$$

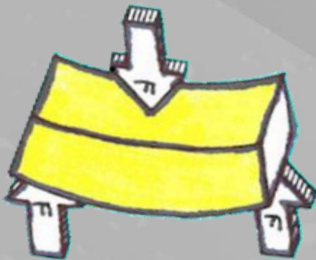

bending

$$\sigma = \frac{M}{W}$$



# Young's modulus determination

- strain  $\epsilon$

$$\epsilon = \frac{\Delta l}{l_0} = \frac{l_1 - l_0}{l_0}$$

$\Delta l$  .... change of the length [mm]

$l_1$  ..... length after elongation [mm]

$l_0$  ..... original (initial) length [mm]

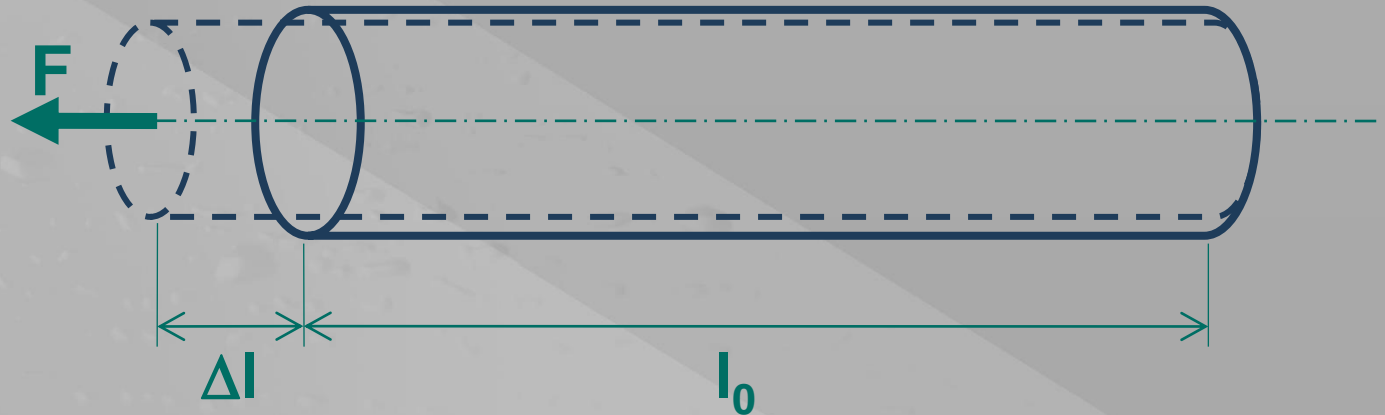
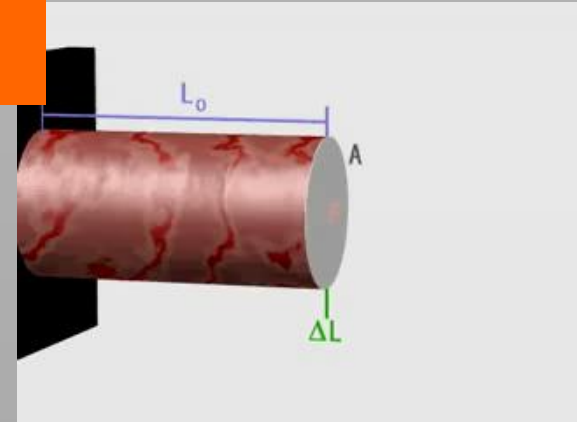



# Measuring of elongation $\Delta l$

- deformations  $\Delta l$  have to be measured by special devices - **strain gauge**

## Strain gauge:

- mechanical
- electrical
- optical

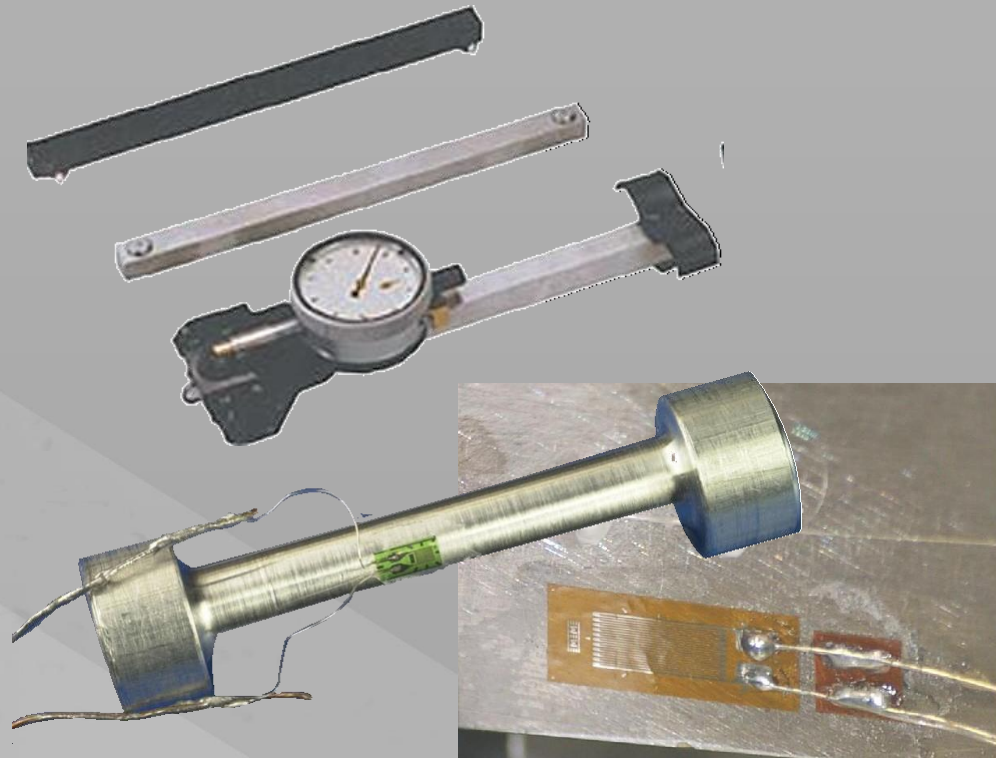





# Mechanical strain gauge

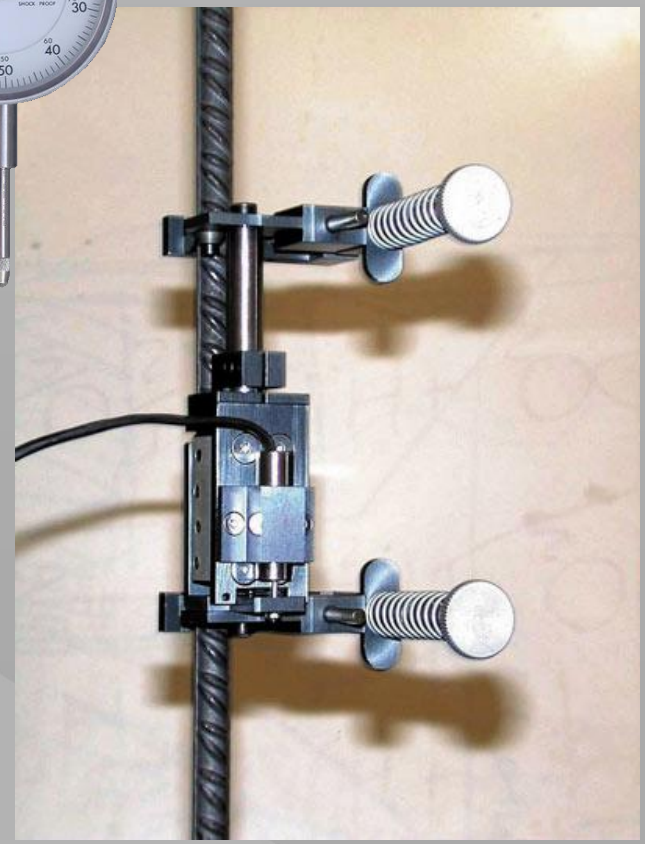
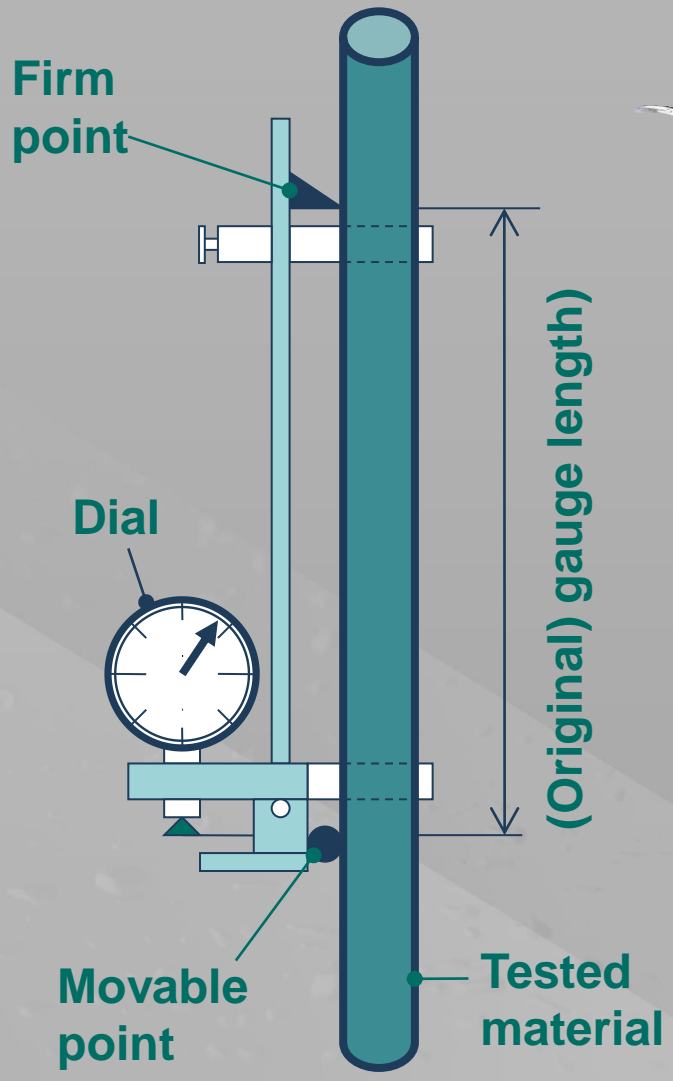



# Measuring of deformations





# Electrical resistance gauge

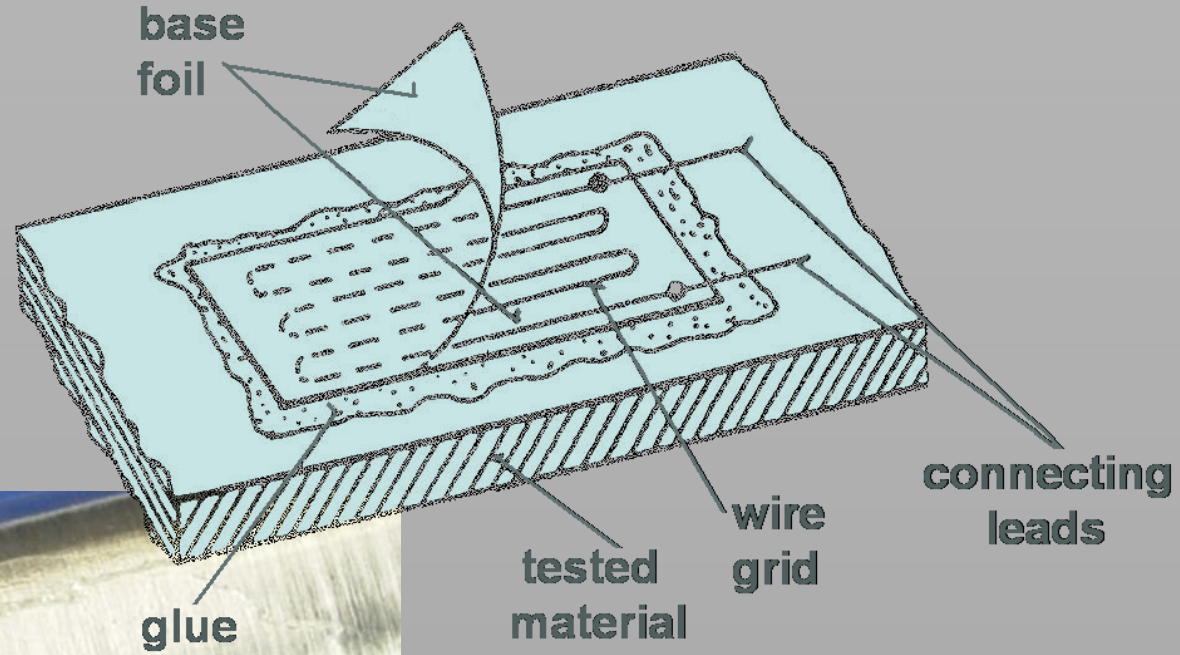

$$\frac{\Delta I}{I} = \frac{1}{K} \cdot \frac{\Delta R}{R}$$



# Optical strain gauge

- optical fibers
- laser

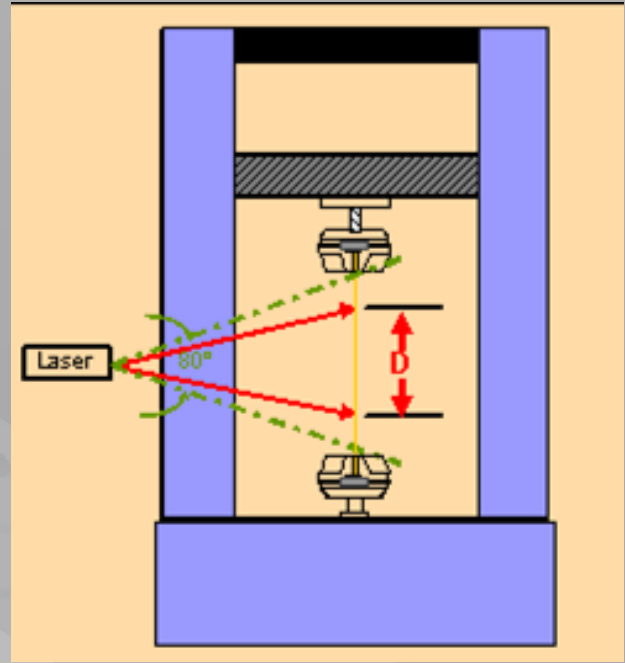
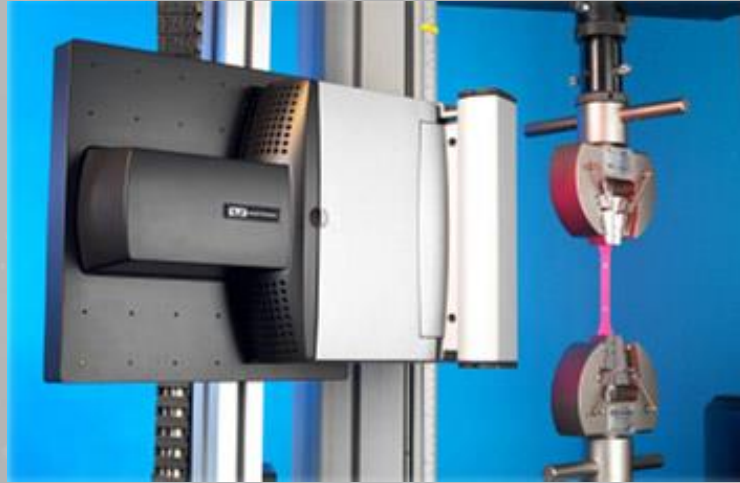
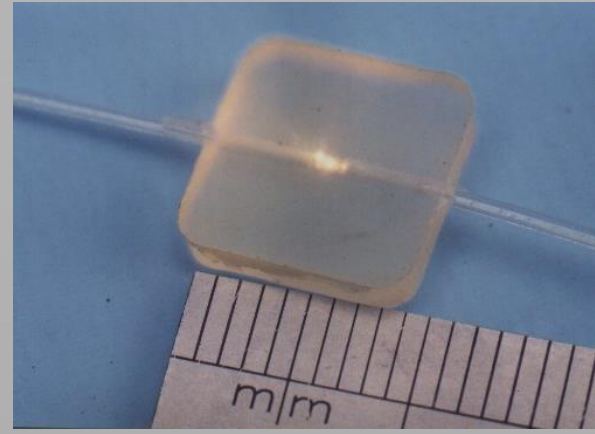



# Dynamic Young's modulus

- ultrasonic waves

$$E_{\text{dyn}} = c^2 \cdot \rho_v$$



$c$ ... sound velocity [ $\text{m}^2 \cdot \text{s}^{-1}$ ]

$\rho_v$ ... bulk density [ $\text{kg} \cdot \text{m}^{-3}$ ]



# Measuring of dynamic Young's modulus

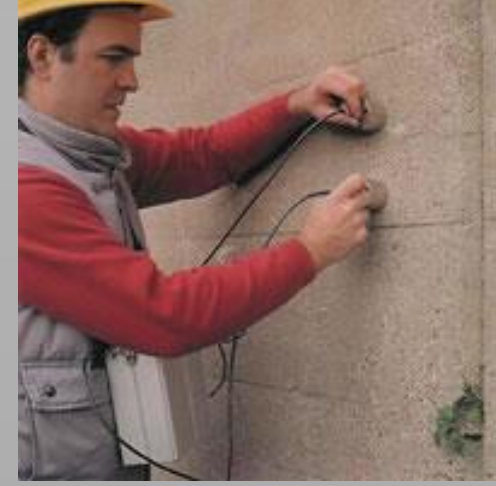



# Elastic modulus is affected by:

- **temperature**
  - thermoplastics: with rising temperature  $E$  significantly decreases
  - concrete :
    - 20 °C - +70 °C -  $E$  constant
    - under -50 °C - ca. about 20 % higher
    - above 300 °C - ca. 50 % of initial value
- **moisture** – in porous materials



# Young's modulus of some materials

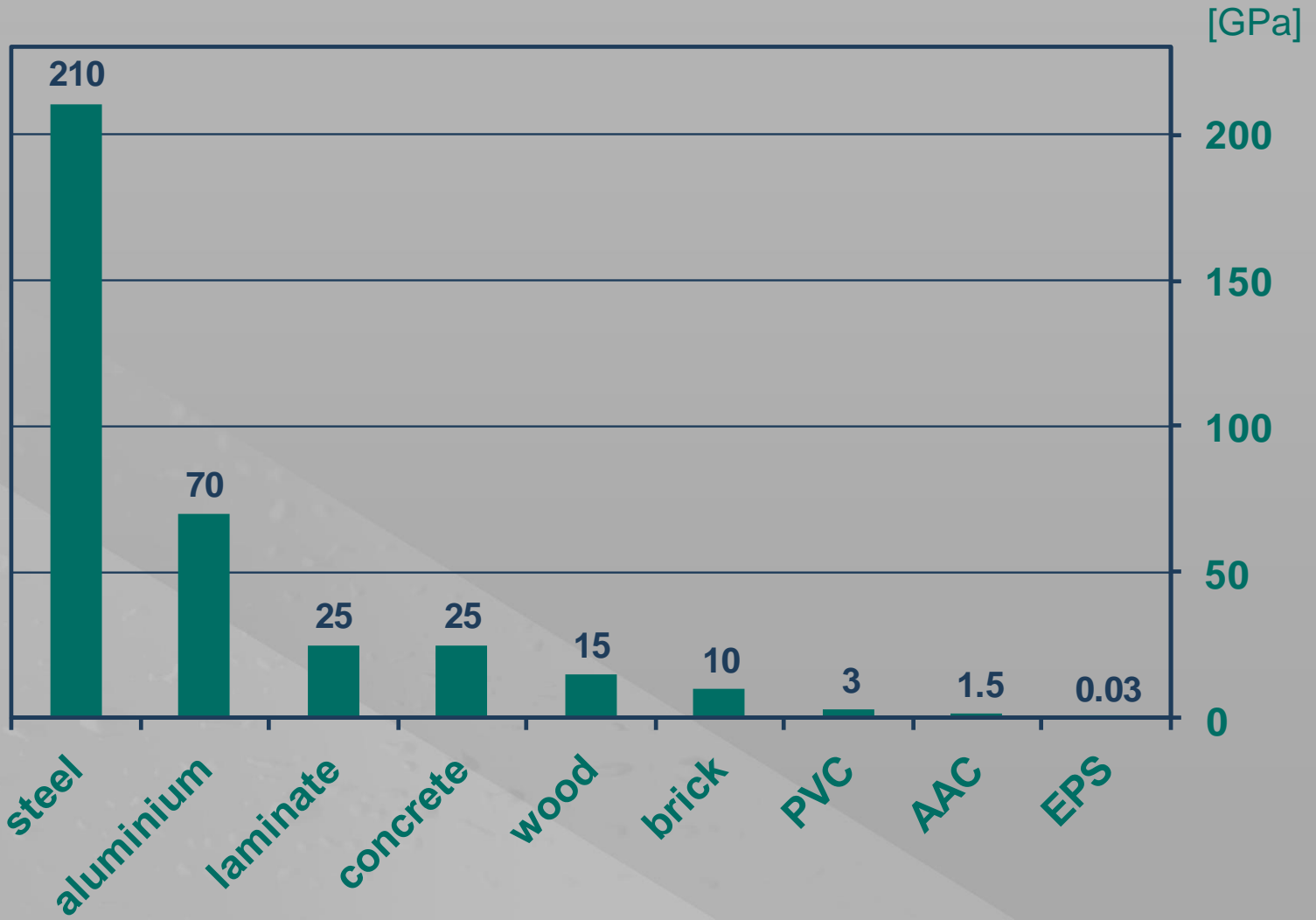





# Building materials

Department of Materials Engineering and Chemistry  
Faculty of Civil Engineering

Material	Young's modulus [GPa]
Diamond	1050-1200
Steel	210
Glass	50 -85
Aluminium and light alloys	65 -73
Brass and bronze	103-124
Concrete	15 - 60
Ceramic brick	8 - 12
Wood	7 -18
Glass laminate	10 - 30
Thermosets	4 - 13
Thermoplastics solid	0,1 - 4
Thermoplastics foamed	0,02 – 0,3
Rubber	0,002 –0,005

**Department of Materials Engineering  
and Chemistry**

**Faculty of Civil Engineering**



## **Building materials**



# Ductility

- percentage elongation after tensile test

$$A(\delta) = \frac{L_u - L_0}{L_0} = \frac{\Delta L}{L_0}$$

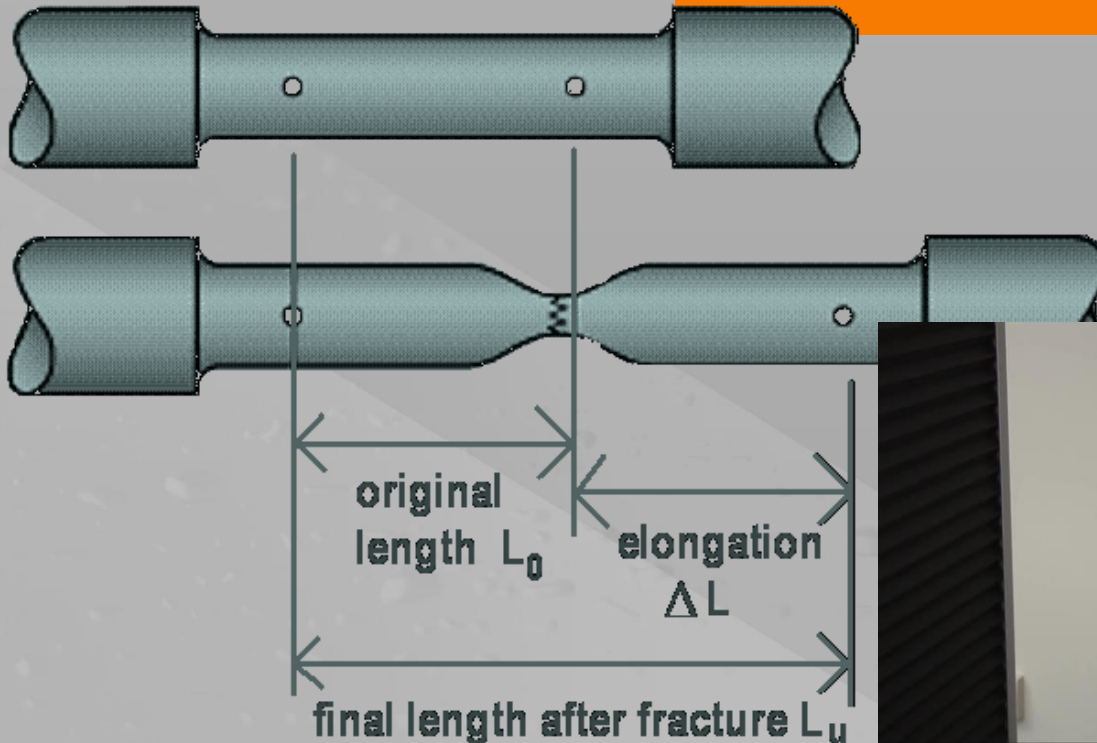



# Reduction of area

- change of cross sectional area as a percentage of the original cross-sectional area

$$Z(\psi) = \frac{S_0 - S_u}{S_0}$$

$S_0$ ..... original cross-sectional area before testing

$S_u$ ..... minimal cross-sectional area after failure

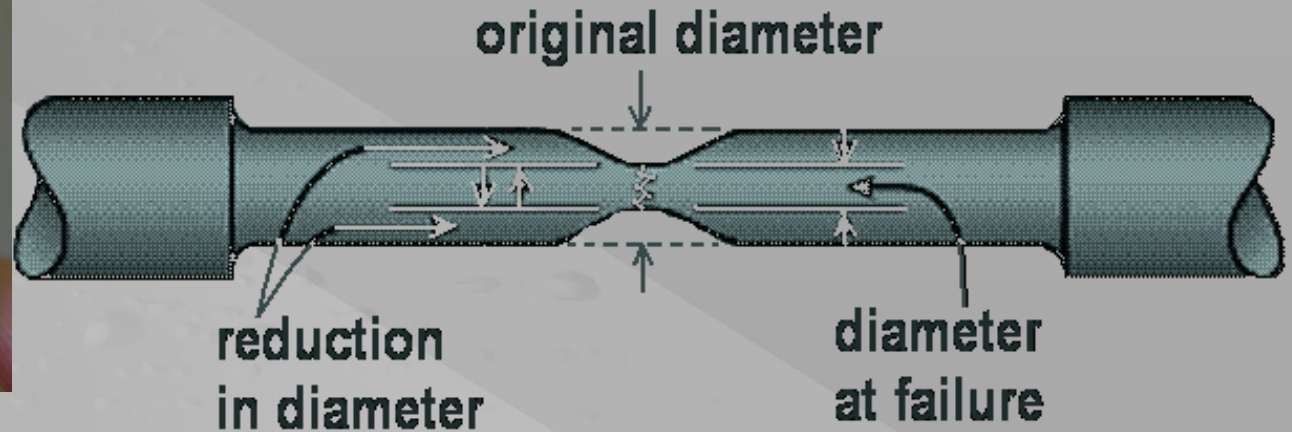



# Brittle x tough materials

- **brittle** material, subjected to stress, breaks without significant deformation
- **tough** material deforms plastically and absorbs energy before fracture

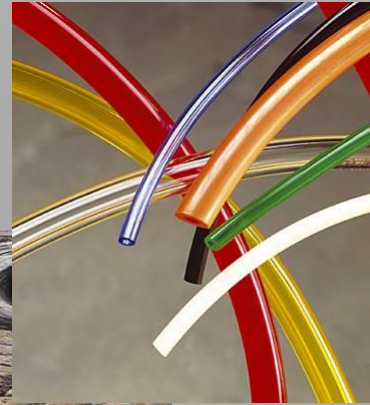
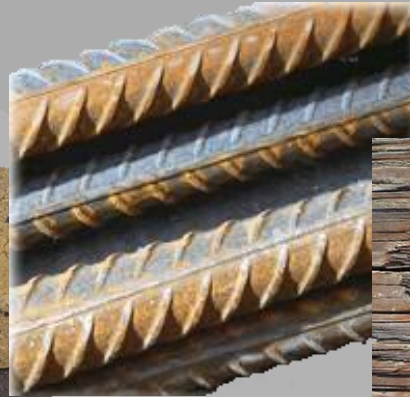
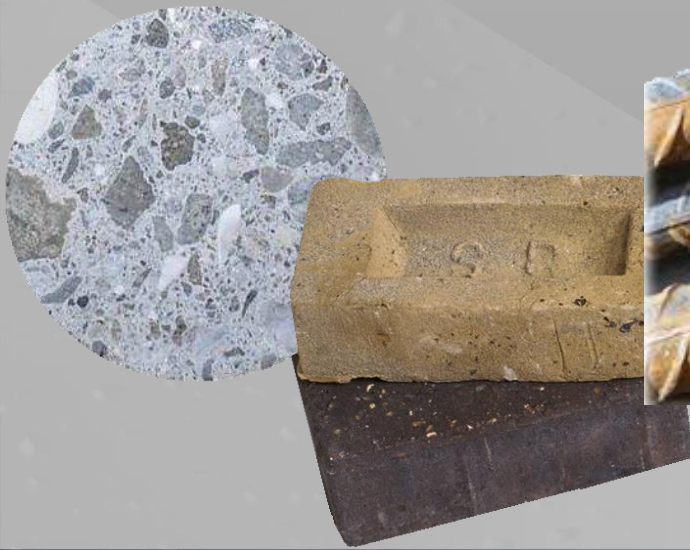



# Toughness

- the amount of energy per volume that a material can absorb before rupturing
- units:  $\text{kJ/m}^3$

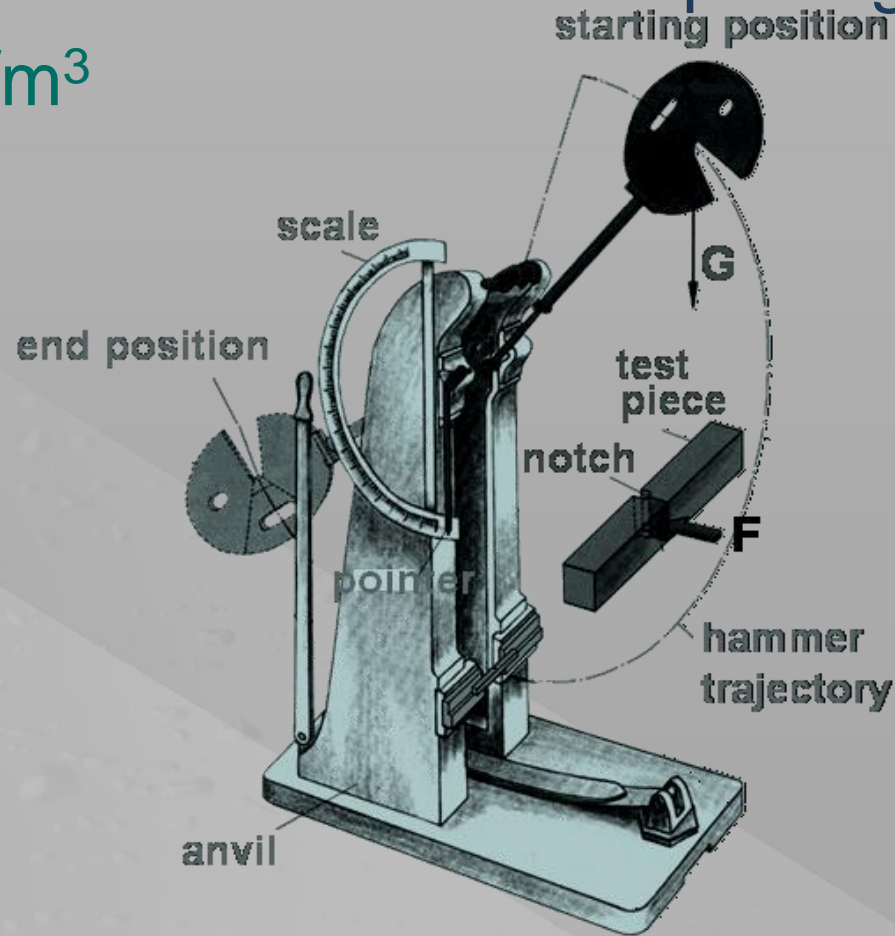



# Test of toughness

- impact toughness
  - Charpy, Izod test
- notch toughness  
(ability to absorb energy in the presence of a flaw)

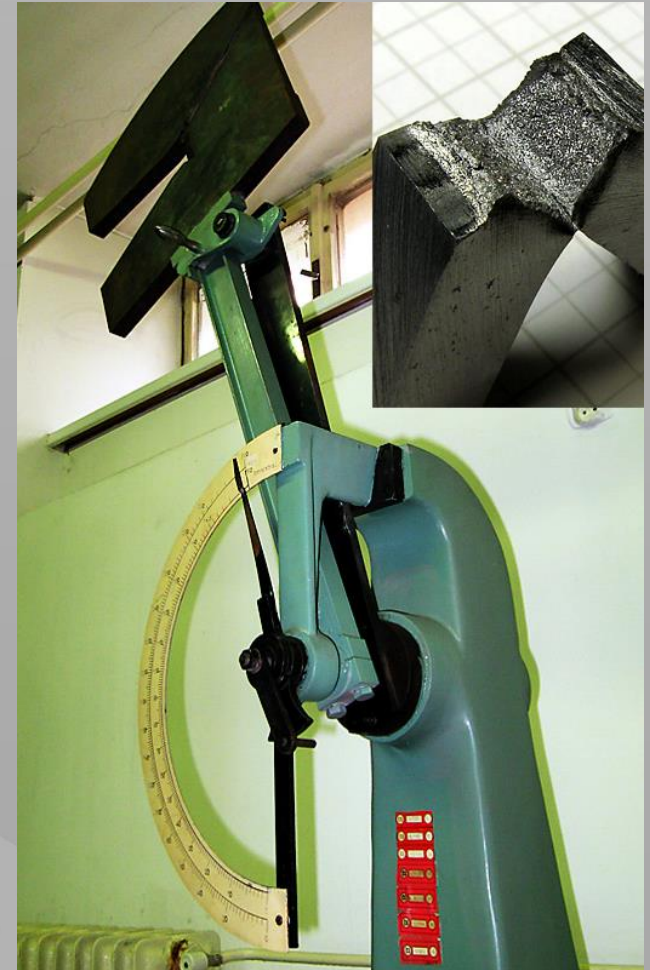
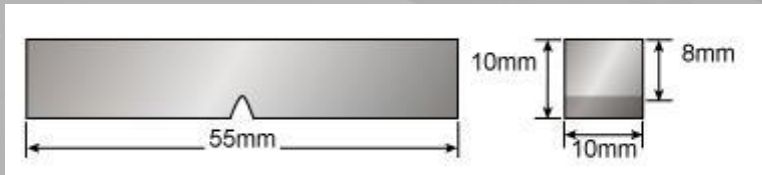



# Charpy impact test







# Brittleness

- tendency of a material to fracture or fail upon the application of a relatively small amount of force, impact, or shock
- opposite of toughness
- no numerical value



Rough criterion for brittle materials:  
**compressive strength : tensile strength**  
**> 8 : 1**

**Department of Materials Engineering  
and Chemistry**

**Faculty of Civil Engineering**



**Building materials**



# Hardness

- defines the materials resistance to penetration
- depends on temperature and moisture
- Methods:
  - **scratch hardness**
  - **indentation hardness**
  - **rebound hardness**

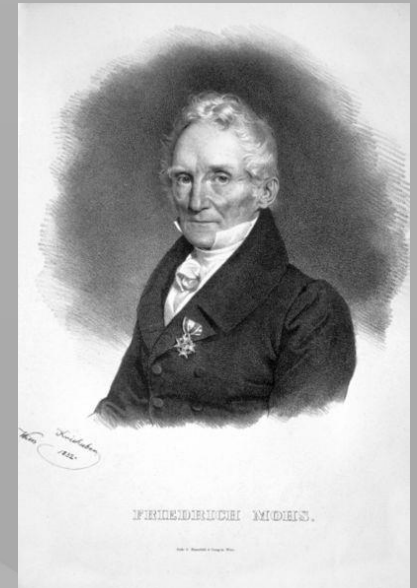



# Scratch h. – Mohs scale

1. talc
2. gypsum
3. calcite
4. fluorite
5. apatite
6. feldspar (orthoclase)
7. quartz
8. topaz
9. corundum
10. diamond



- used for minerals



# Indentation h. – Vickers test

- indenter: diamond point with a 136° point angle
- abbreviation **VHN**
- metals, hard materials



$$HV = 0,102 \times \frac{2F \sin \frac{136^\circ}{2}}{d^2} = 0,1891 \frac{F}{d^2}$$

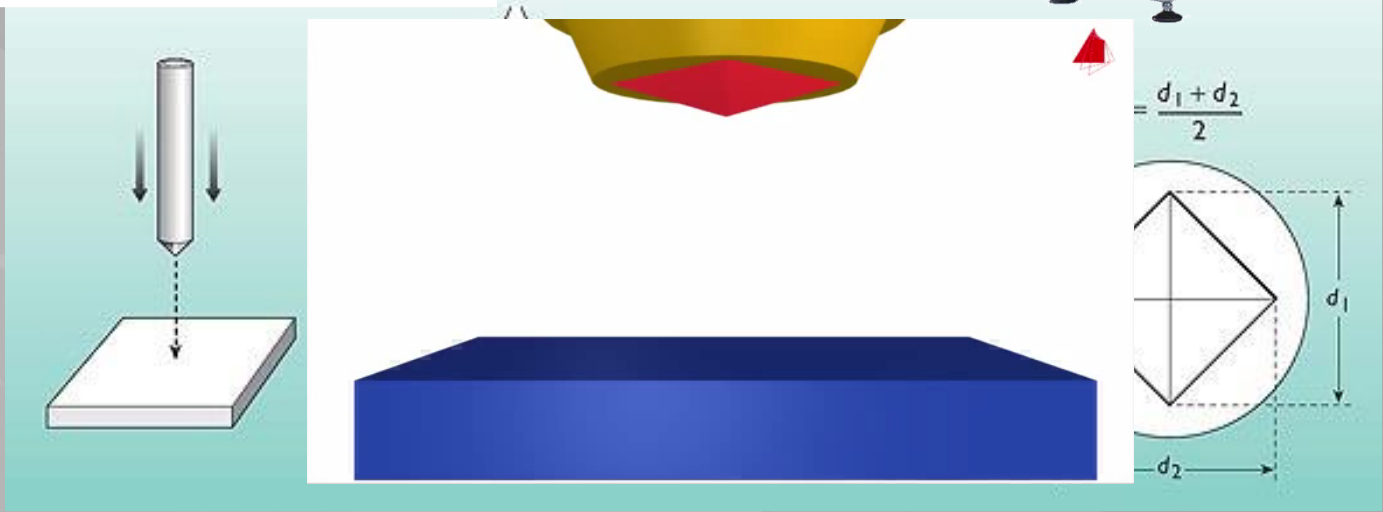



# Indentation h. – Brinell test

- indenter: steel (tungsten) ball (10 mm  $\varnothing$ )
- abbreviation: **HBW, (HBS)**
- metals, wood, hard polymers

$$HB = 0,102 \frac{2F}{\pi \cdot D \cdot (D - \sqrt{D^2 - d^2})}$$

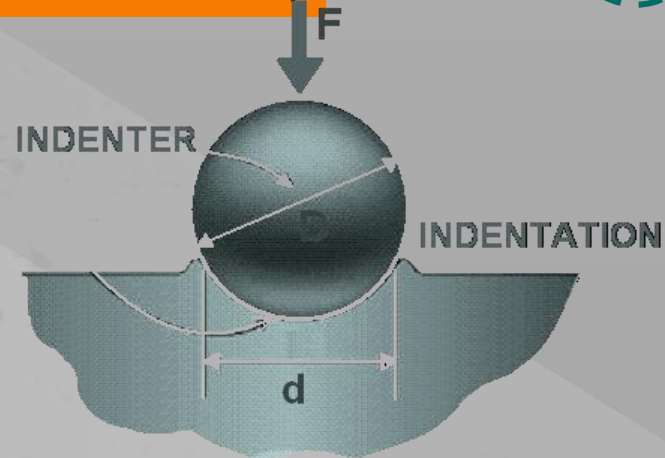



# Indentation h. – Rockwell test

- diamond cone
- abb.: **HR**(A,B,C..G)
- depth of indentation
- metals

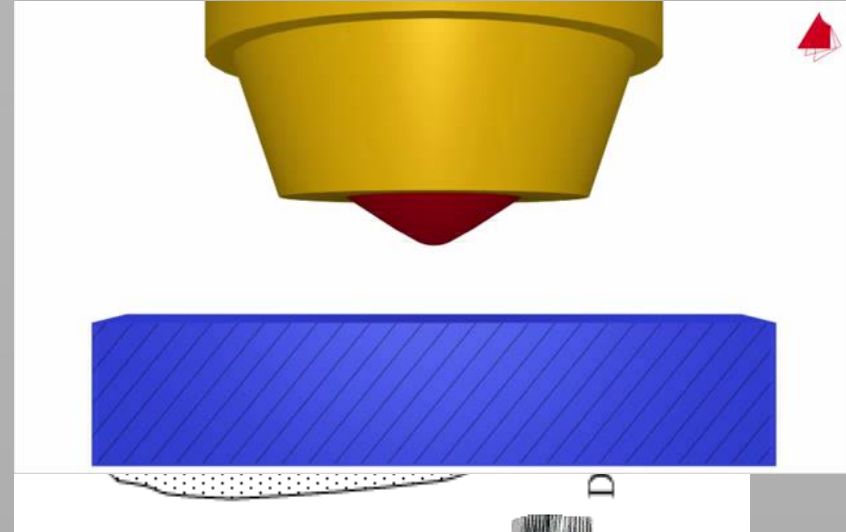

## Shore durometer

- spring+ steel rod
- abb.: **SH**
- polymers, elastomers, rubber





# Hardness conversion

- indicative only

**Hardness Conversion**

Convert From

Rockwell B Hardness (HRB)  
 Rockwell C Hardness (HRC)  
 Vickers Hardness (HV)  
 Knoop Hardness (HK)  
 Scleroscope Hardness (HS)

Rockwell C Hardness (HRC)

Brinell Hardness (HB)

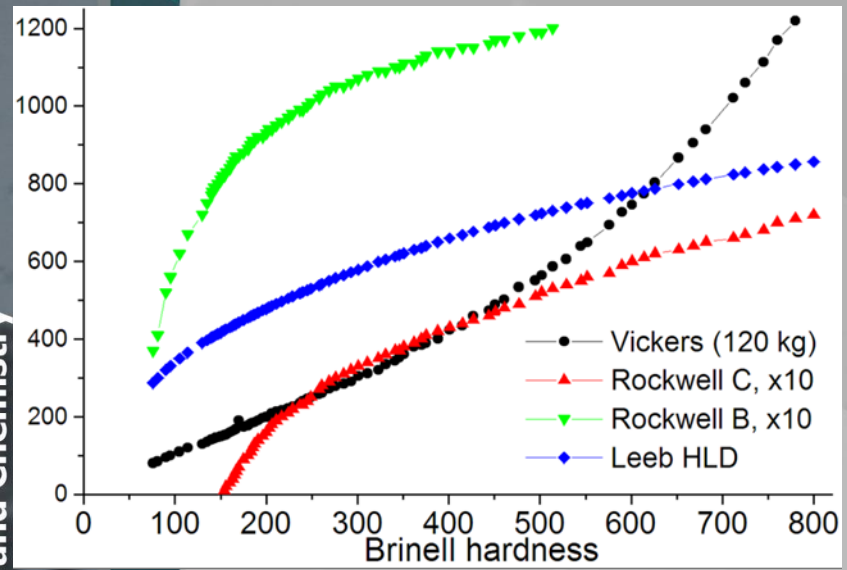

## HARDENED STEEL AND HARD ALLOYS

Rockwell*				Superficial			Vickers	Knoop	Brinell	Tensile Strength	Micro-ficial
C	A	D	G	15-N	30-N	45-N	HV	HK	HB	KSI	WMN
150 kg Brale*	60 kg Brale	100 kg Brale	150 kg 1/16" ball	15 kg N Brale	30 kg N Brale	45 kg N Brale	10 kg	500 gm and over	3000 kg 10 mm ball	1000 lbs/sq in	1000 gm
80	92.0	86.5	▲	96.5	92.0	87.0	1865	-	▲	▲	-
79	91.5	85.5		96.3	91.5	86.5	1787	-			-
78	91.0	84.5		96.0	91.0	85.5	1710	-			-
77	90.5	84.0		95.8	90.5	84.5	1633	-			-
76	90.0	83.0		95.5	90.0	83.5	1556	-			-
75	89.5	82.5		95.3	89.0	82.5	1478	-			-
74	89.0	81.5		95.0	88.5	81.5	1400	-	NOTE 1	NOTE 2	-
73	88.5	81.0		94.8	88.0	80.5	1323	-			-
72	88.0	80.0		94.5	87.0	79.5	1245	-			-
71	87.0	79.5		94.3	86.5	78.5	1160	-			-
70	86.5	78.5		94.0	86.0	77.5	1076	972			953
69	86.0	78.0		93.5	85.0	76.5	1004	946			949
68	85.6	76.9		93.2	84.4	75.4	940	920			945
67	85.0	76.1		92.9	83.6	74.2	900	895			942
66	84.5	75.4		92.5	82.8	73.3	865	870	NA		938
65	83.9	74.5		92.2	81.9	72.0	832	846	739		934
64	83.4	73.8		91.8	81.1	71.0	800	822	722		930
63	82.8	73.0		91.4	80.1	69.9	772	799	706		926
62	82.3	72.2		91.1	79.3	68.8	746	776	688		922
61	81.8	71.5		90.7	78.4	67.7	720	754	670		917
60	81.2	70.7		90.2	77.5	66.6	697	732	654	NA	913
59	80.7	69.9		89.8	76.6	65.5	674	710	634	351	909
58	80.1	69.2		89.3	75.7	64.3	653	690	615	338	904
57	79.6	68.5		88.9	74.8	63.2	633	670	595	325	900
56	79.0	67.7		88.3	73.9	62.0	613	650	577	313	896
55	78.5	66.9		87.9	73.0	60.9	595	630	560	301	891
54	78.0	66.1		87.4	72.0	59.8	577	612	543	292	887
53	77.4	65.4		86.9	71.2	58.6	560	594	525	283	883
52	76.8	64.6		86.4	70.2	57.4	544	576	512	273	879
51	76.3	63.8		85.9	69.4	56.1	528	558	496	264	874
50	75.9	63.1		85.5	68.5	55.0	513	542	481	255	870
49	75.2	62.1		85.0	67.6	53.8	498	526	469	246	865
48	74.7	61.4		84.5	66.7	52.5	484	510	455	238	861
47	74.1	60.8		83.9	65.8	51.4	471	495	443	229	856





# Indentation h.–**POLDI hammer**

- Comparison of the indentation size of tested material and reference material with known hardness





# Rebound h. – Schmidt hammer

- measures the rebound of a spring-loaded mass impacting against the surface of the sample

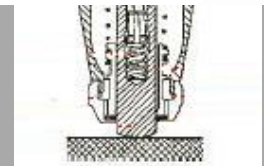
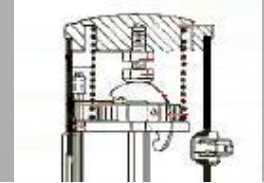



# Correlation between Schmidt rebound number and the compressive strength

- the rebound value can be used to determine the compressive strength (by reference to the conversion chart)

Depends on:

- orientation of the hammer
- water content

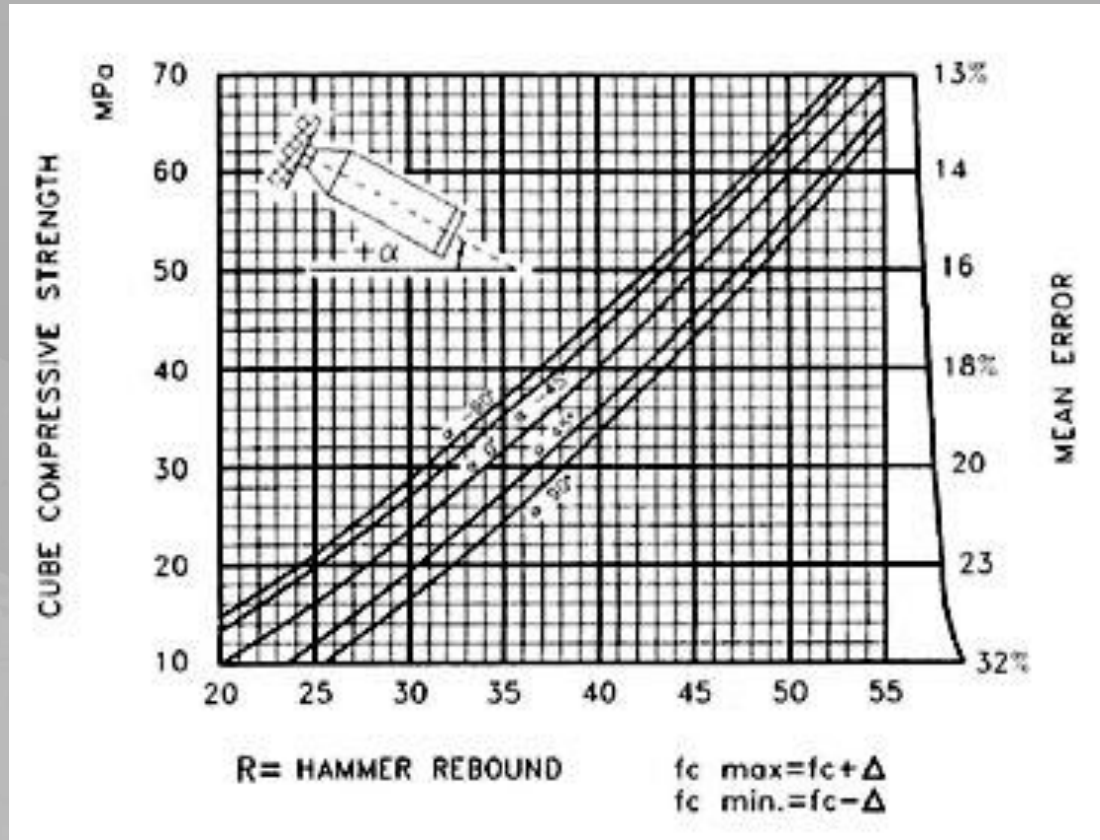

**Department of Materials Engineering  
and Chemistry**

**Faculty of Civil Engineering**



**Building materials**



# Fatigue



- fatigue occurs when a material is subjected to repeated loading and unloading
- cyclic stress causes the decrease of the strength
- typical for metals



**Fatigue limit (strength)** = the amplitude (or range) of cyclic stress that can be applied to the material without causing fatigue failure



# Fatigue

- if the loads are above a certain threshold, microscopic cracks will begin to form
- after reaching critical size, and the structure will suddenly (without warning) fracture
- the shape of the structure affect the fatigue life (square holes, sharp corners)
- the greater the applied stress range, the shorter the life
- damage is cumulative, materials do not recover when rested
- f. is influenced by a variety of factors (temperature, surface finish, microstructure, presence of oxidizing or inert chemicals, residual stresses, etc.)



# Endurance limit

- some materials (ferrous and titanium alloys) have a distinct limit below which there appears to be no number of cycles that will cause failure
- some structural metals (aluminium, copper) do not have a distinct limit and will eventually fail even from small stress amplitudes

S-N (Wöhler) curves

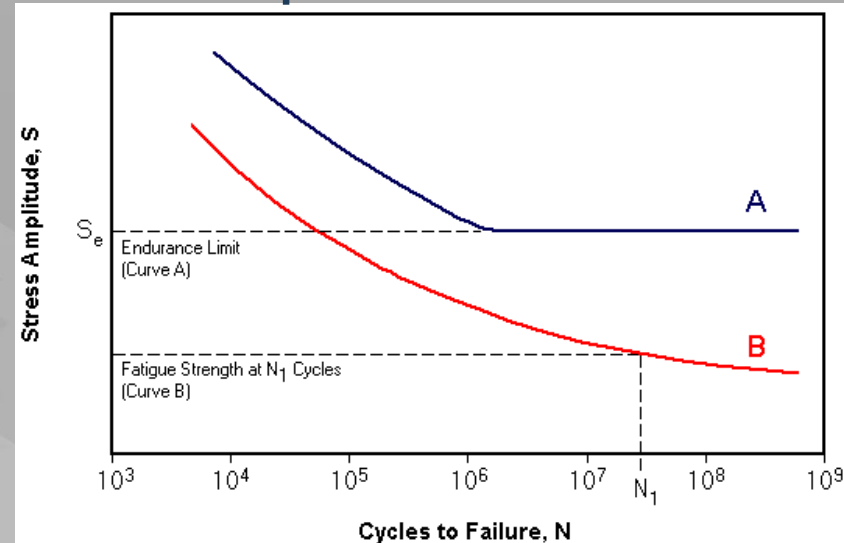



# Fatigue cracks

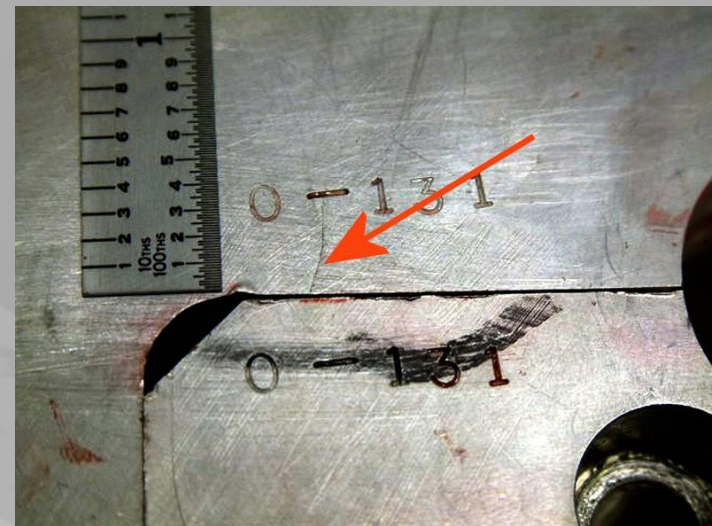
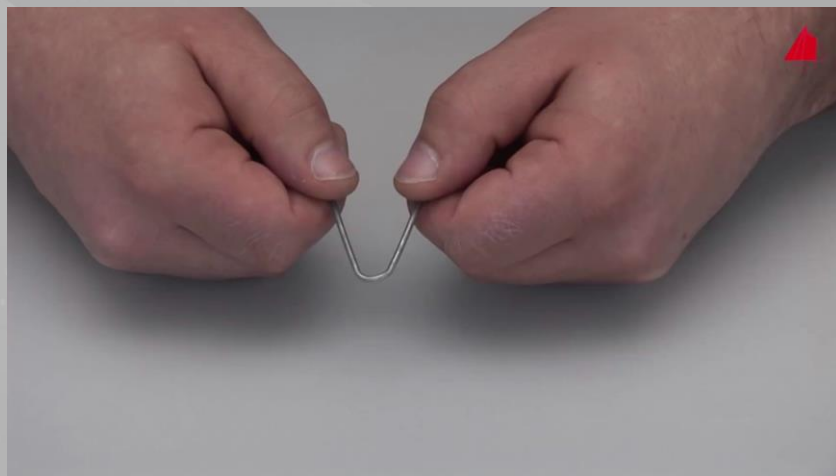
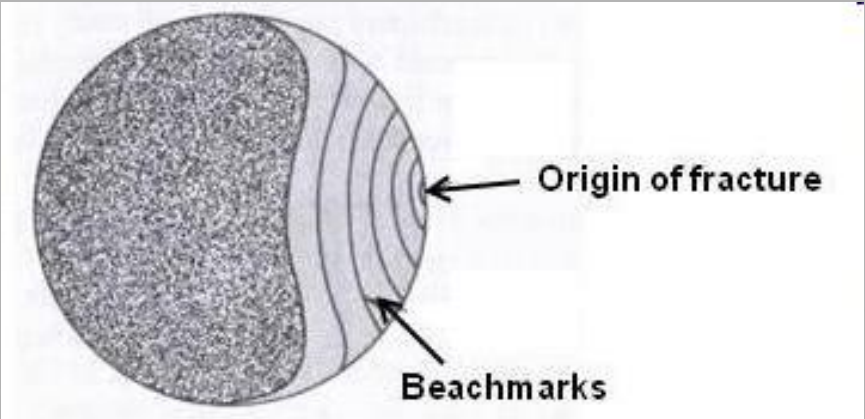





# Fatigue testing

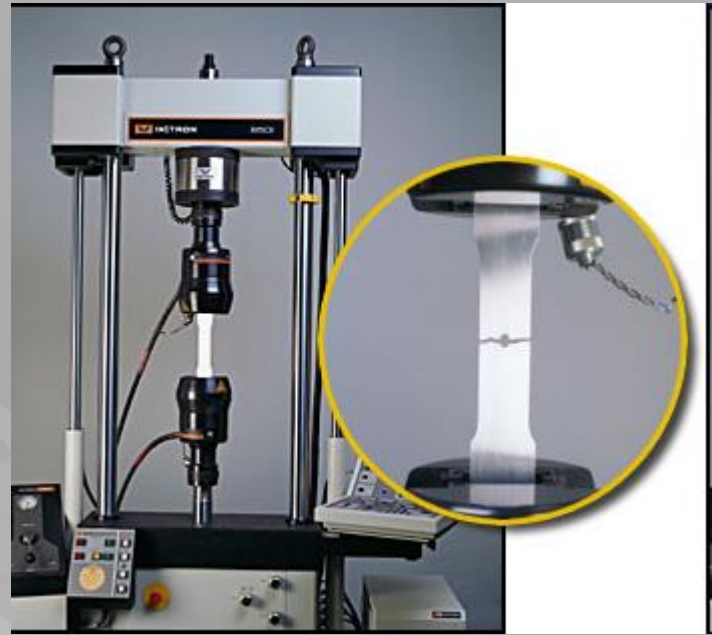
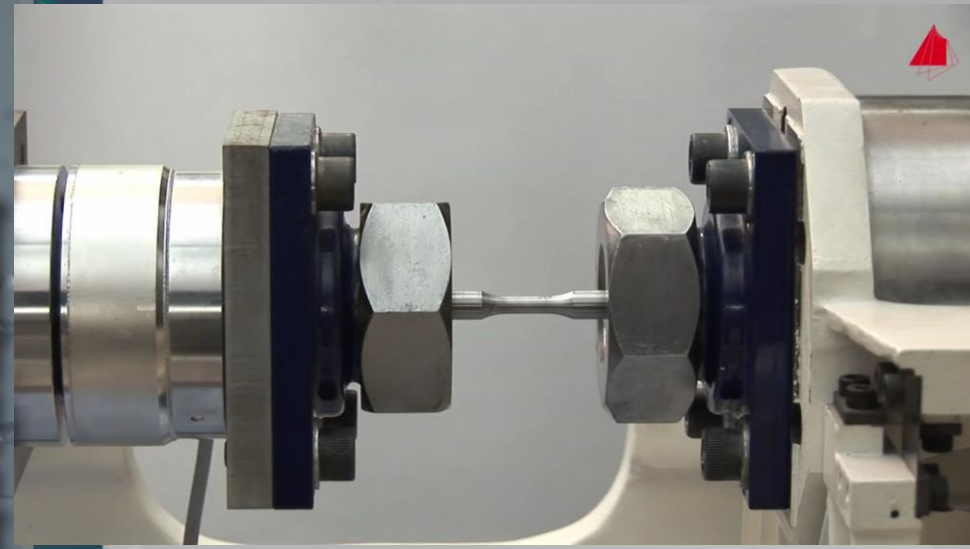
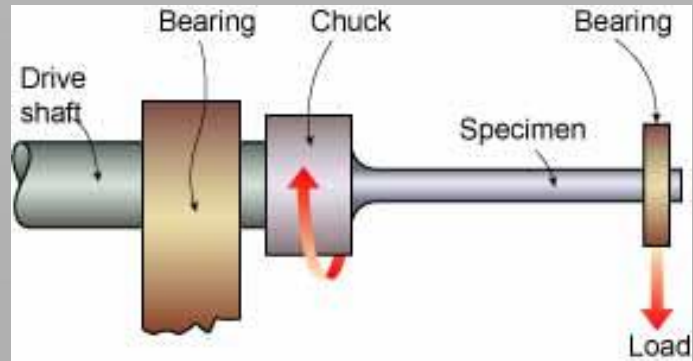



# Infamous fatigue failures

- Boston Molasses Disaster  
(USA, Boston, 1919)



VIA MYSWINGARCHIVES.BLOGSPOT.COM



# Infamous fatigue failures

- Alexander L. Kielland oil platform capsized (Norway, 1980)

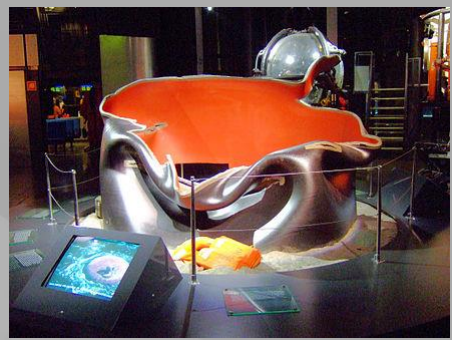
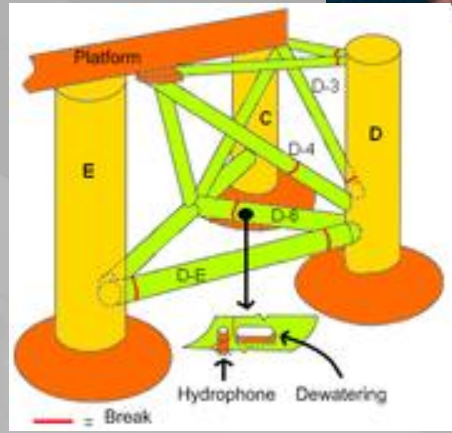



# Infamous fatigue failures

- InterCity expres (Germany, Eschede, 1998)
  - fatigue crack in one wheel

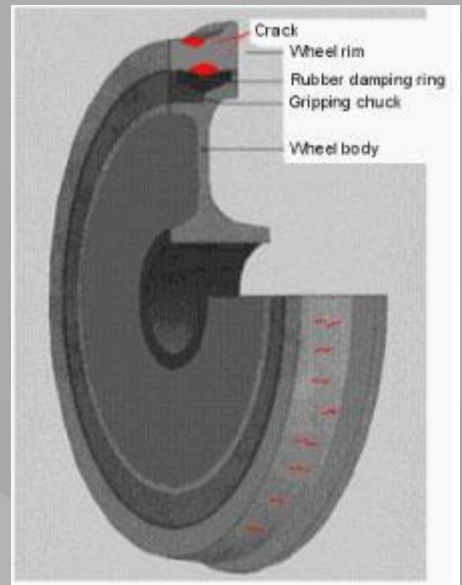
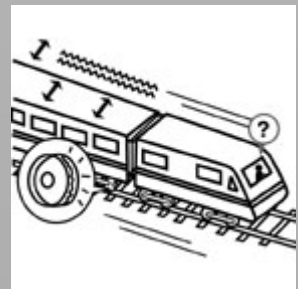



# Dynamic strength

- Tacoma narrows bridge (USA, Washington, 1940)





# Abrasion resistance

- ability of a surface to resist being worn away by rubbing or friction
- coatings, paints, floor surfaces, pipes





# Abrasion resistance tests

- usually measured as a loss percentage based on original weight
- big scale of different tests

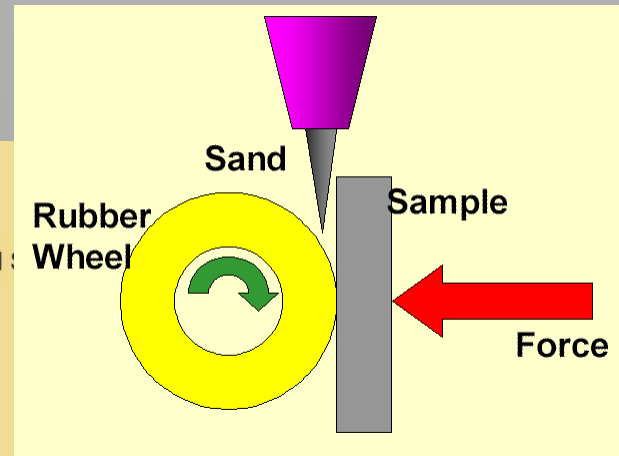
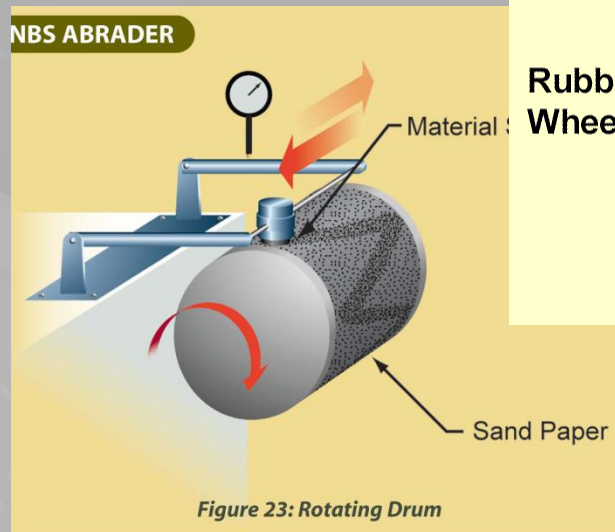
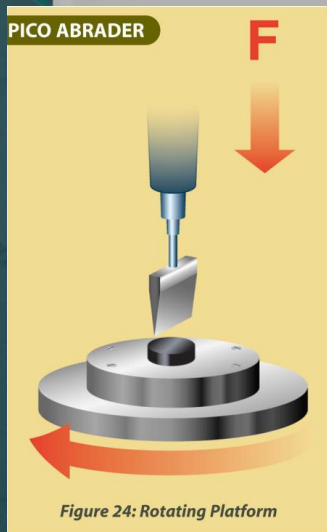



# Abrasion resistance tests

## Taber abrader

- thickness loss after defined number of rotations using standardized wheel and defined load

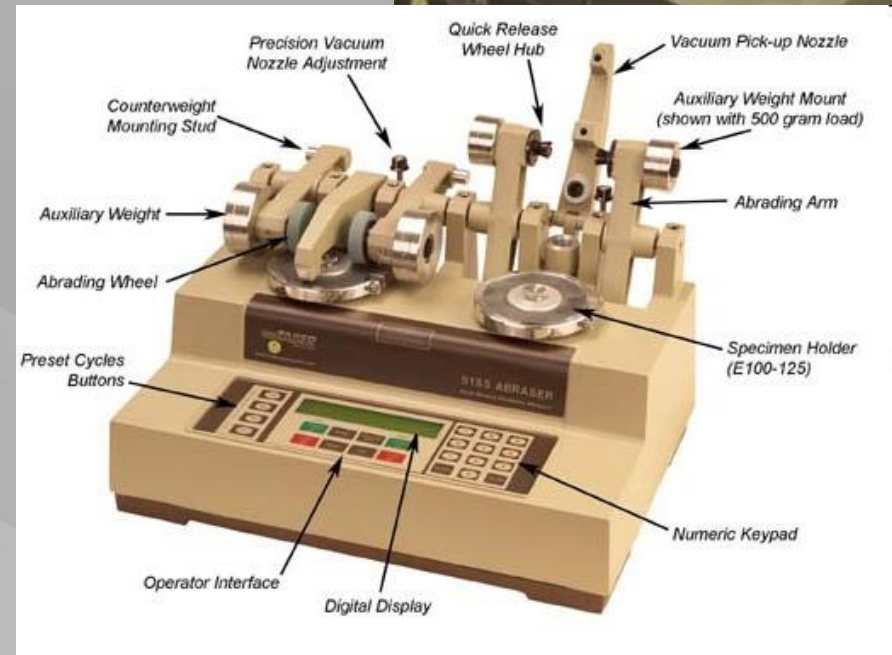
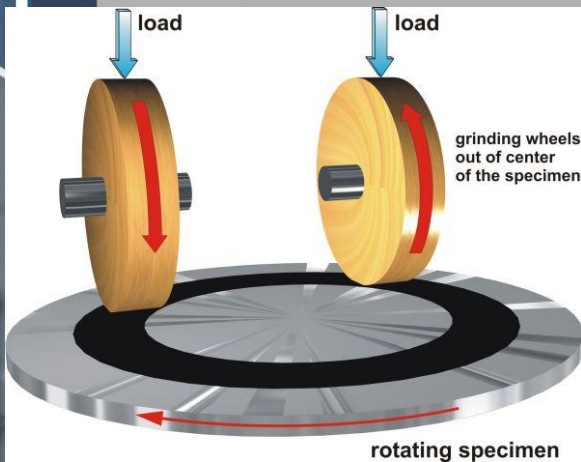





## Comparative Abrasion Resistance of Various Polymers

Material	Weight Loss (mg)
thermoplastic urethane	0.4-3.2
ionomer	12
nylon 6/10	16
nylon 11	24
HDPE	29
polytetrafluorethylene	42
nitrile rubber	44
nylon 6,6	58
LDPE	70
rigid PVC	122
natural rubber (tread formulation)	146
SBR (premium tread formulation)	177
SBR (tread formulation)	181
plasticized PVC	187
butyl rubber	205
ABS	275
neoprene (polychloroprene)	280
polystyrene	324

Taber abrasion, CS17 wheel, 1000 gm weight, 5000 revolutions  
Ref: Handbook of Thermoplastic Elastomers, Litton Educational Publishing,



# Abrasion resistance tests

## Amsler/Böhme test

- a specimen is subjected to stress by grinding
- the abrasive grit accumulating from this is indicated as loss of volume or thickness (abrasive loss) per test area  $50 \text{ cm}^2$

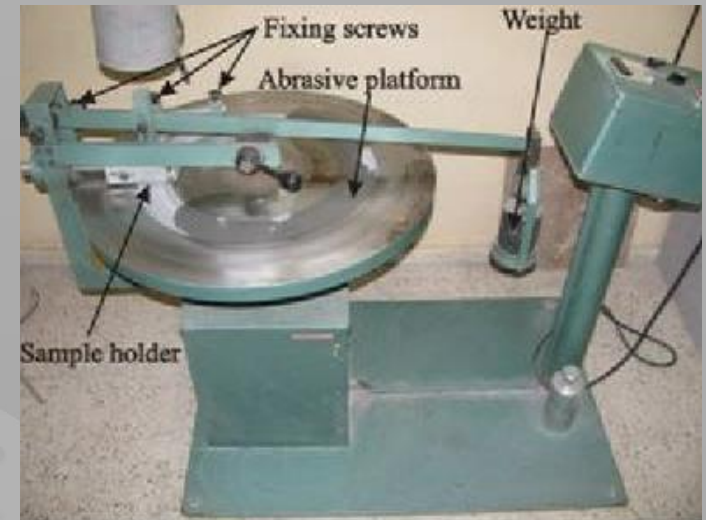
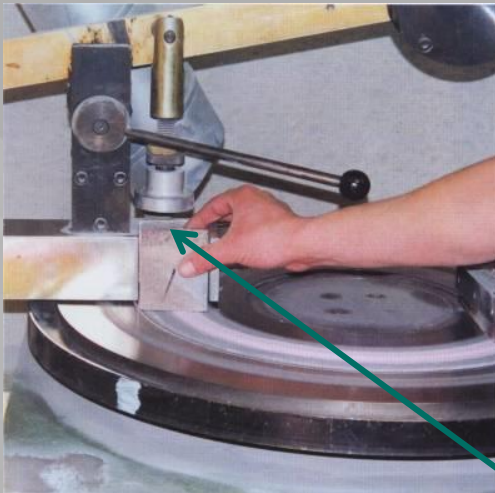

test area  $7,07 \times 7,07 \text{ cm}$



# Abrasion resistance - standards (Amsler / Böhme)

- EN 1338, 1339, 1340 – concrete pavings
- EN 14157 – natural stones
- EN 13 892-3 – screeds

	abrasion resistance					cm <sup>3</sup> /50 cm <sup>2</sup>
	100	80	60	40	20	
Granite + Tonalite						
Syenite + Gabbro						
Lava						
Vulcanic tuff						
Sandstone						
Clay shale						
Limestone compact						
Limestone porous						
Marble						
Serpentinite						
Paragneiss						
Quarzite						

Fig. 3.70 Böhme test abrasion values for different rock types including their range of dispersion (modified after Müller 2001). Note, higher values (from right to left) indicate a rock having a lower abrasion resistance, lower values indicate a higher abrasion resistance



# Underwater Method

- **ASTM C1138: Standard Test Method for Abrasion Resistance of Concrete**



Sample Before Test



Set-up sample for apparatus



Test in progress – Between Cycles

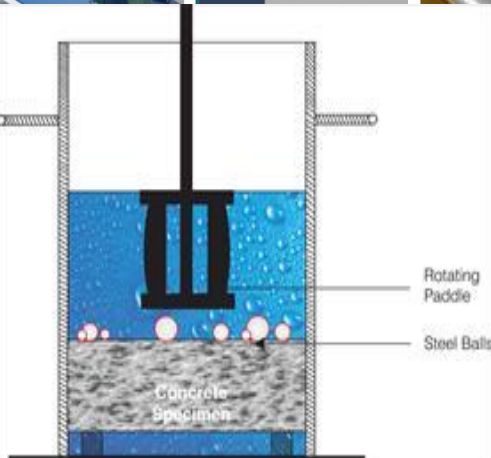

Sample removed from Apparatus – Between Cycles



Sample Between Cycles



Sample After 6 Cycles (Each Cycle is 12 Hours)



# Adhesion and cohesion

- **adhesion** – state in which two surfaces are held together by interfacial effects
- **cohesion** – ability of a material to maintain its strength when unconfined

**adhesion < cohesion**



# Adhesion

- between two materials - in composites (steel + concrete, cement + aggregates...)





# Adhesive strength

- between the upper layer and base (plasters, coatings..)





# Pull-off test

- the circular pull-head plates are glued to the test material and upper layer is cut around them

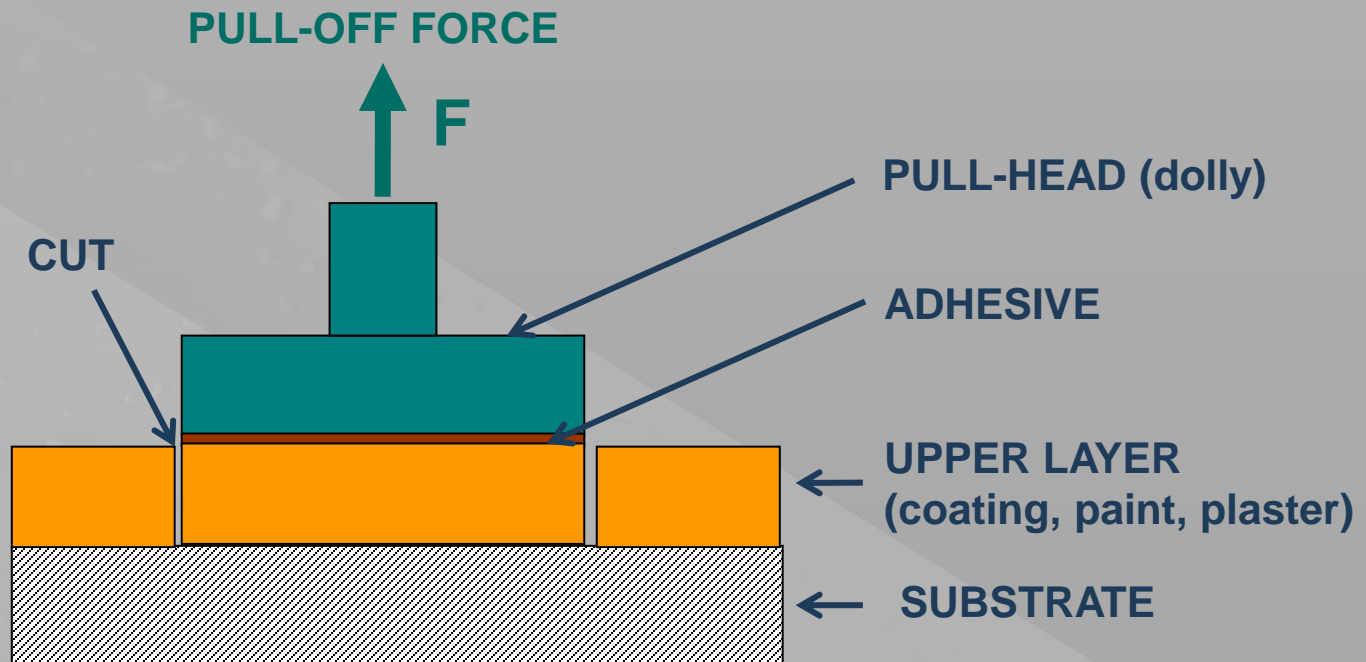





# Pull-off test equipment



Pull-off Adhesion Testing  
Instructional Video





# Adhesive strength $f_a$

- test results:

$$f_u = \frac{F_u}{A}$$

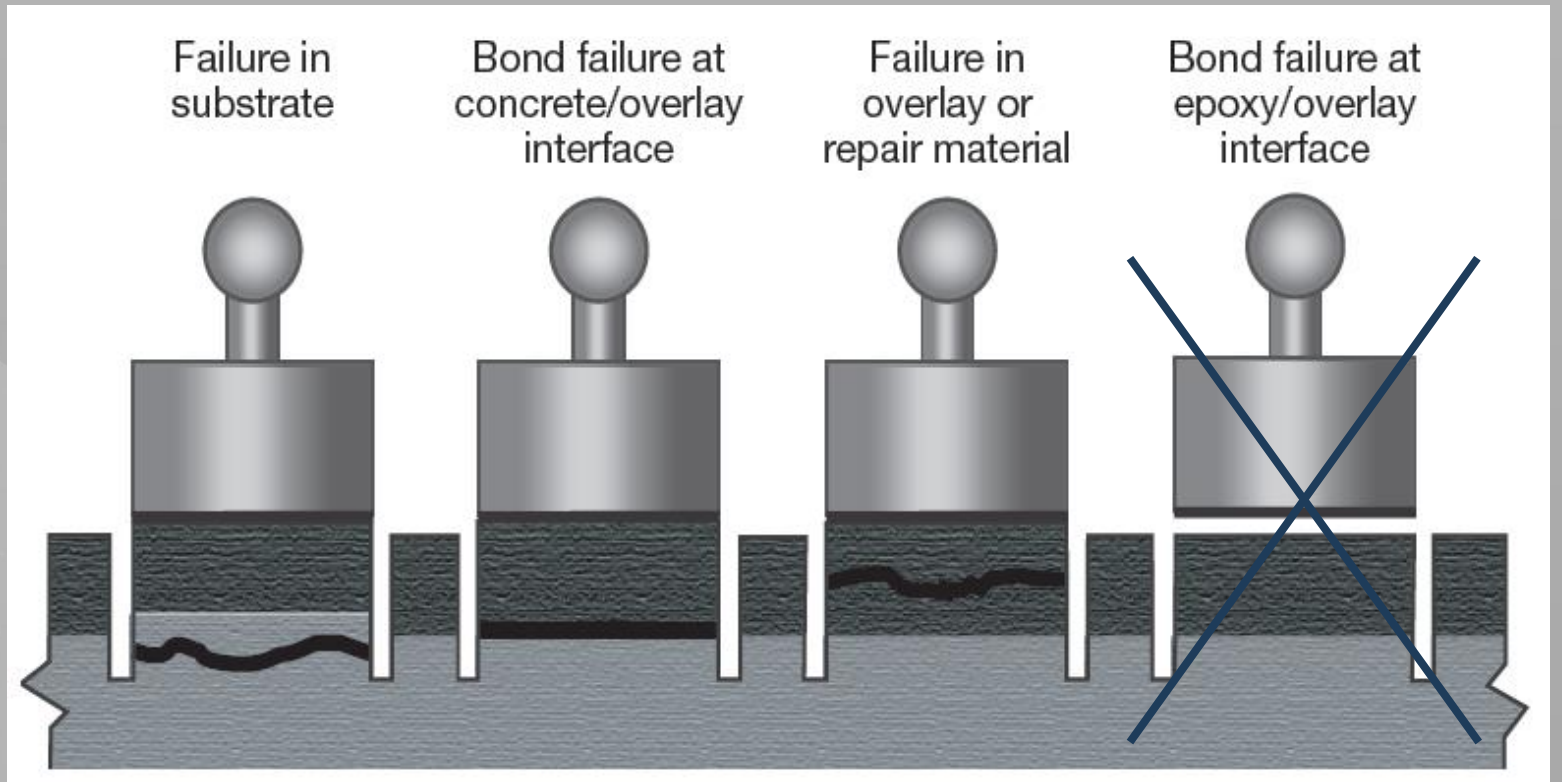

$f_a > f_u$

$f_a = f_u$

$f_a > f_u$

invalid result